

Distributed by
Raymarine

Any reference to Raytheon or RTN in this manual should be interpreted as Raymarine. The names Raytheon and RTN are owned by the Raytheon Company.

hsb² **PLUS Series** **Color LCD Display**

Owner's Handbook

Document number: 81188_2
Date: 14th December 2001

*hsb*² Series Color LCD Display Owner's Handbook

December 2001

INTENDED USE

The display units detailed in this handbook may form part of navigational radar systems intended for light marine use. These displays and radar systems are only an aid to navigation.

SAFETY NOTICES

This radar equipment must be installed and operated in accordance with the instructions contained in this manual. Failure to do so can result in personal injury and/or navigational inaccuracies. In particular:



1. HIGH VOLTAGE. The LCD display unit and scanner unit contain high voltages. Adjustments require specialized service procedures and tools only available to qualified service technicians – there are no user serviceable parts or adjustments. The operator should never remove the display unit cover or attempt to service the equipment.

2. ELECTROMAGNETIC ENERGY. The radar scanner transmits electromagnetic energy. It is important that the radar is turned off whenever personnel are required to come close to the scanner to perform work on the scanner assembly or associated equipment.

It is recommended that the radar scanner is mounted out of range of personnel (above head height).

Avoid looking directly at the antenna as your eyes are the most sensitive part of the body to electromagnetic energy.

When properly installed and operated, the use of this radar will conform to the requirements of ANSI/IEEE C95.1-1992 Standard for Safety Levels with Respect to Human Exposure to Radio Frequency Electromagnetic Fields, 3Hz to 300 GHz and NRPB, Board Statement on Restrictions on Human Exposure to Static and Time Varying Electromagnetic Fields and Radiation. *Doc NRPB, NO. 5 (1993)*.

4. NAVIGATION AID. This unit is only an aid to navigation. Its accuracy can be affected by many factors, including equipment failure or defects, environmental conditions, and improper handling or use. It is the user's responsibility to exercise common prudence and navigational judgements. This radar unit should not be relied upon as a substitute for such prudence and judgement.

Raymarine products are supported by a network of Authorized Service Representatives. For information on our products and services, contact either of the following:

UNITED STATES Raymarine Inc.
22 Cotton Road, Unit D
Nashua, NH 03063-4219
Telephone: +1 603 881 5200
 +1 800 539 5539
Fax: +1 603 864 4756

EUROPE Raymarine Limited
Anchorage Park
Portsmouth
Hampshire PO3 5TD
England
Telephone: +44 (0) 23 9269 3611
Fax: +44 (0) 23 9269 4642

Copyright © Raymarine Ltd. 2001

The technical and graphical information contained in this handbook, to the best of our knowledge, was correct as it went to press. However, our policy of continuous improvement and updating may change product specifications without prior notice. As a result, unavoidable differences between the product and handbook may occur from time to time, for which liability cannot be accepted by Raymarine.

Raymarine is a registered trademark of Raymarine Limited.
SeaTalk is a registered trademark of Raymarine Limited.

hsb² is a trademark of Raymarine Limited.

Pathfinder Plus is a trademark of Raymarine Limited.

This product contains technology provided under license by Acorn Group plc. The copyright of this intellectual property is acknowledged by Raymarine Ltd., as are Acorn's trademarks and patents. Acorn's world wide web address is <http://www.acorn.com>.

Preface

This handbook covers the radar and chart aspects of the following *hsb²* (PLUS) series display systems from Raymarine:

System	Display	Scanner	Chartplotter
Pathfinder Radar	RL70C PLUS, RL80C PLUS	Yes	No
Raychart Chartplotter	RC530 PLUS, RC631 PLUS	No	Yes
Combined Pathfinder Radar/Chartplotter	RL70CRC PLUS, RL80CRC PLUS	Yes	Yes

This handbook also describes the use of multi-display systems.

Note: *Radar systems are supplied with an appropriate Raymarine scanner unit and inter-connecting cable. Details for installing the scanner are described in the Pathfinder Radar Scanner Owner's Handbook.*

The Raychart (RC) display units include a cartridge holder assembly which contains two slots for C-MAP NT chart cards.

This handbook contains very important information on the installation and operation of your new equipment. In order to obtain the best results in operation and performance, please read this handbook thoroughly.

Raymarine's Technical Services representatives or your local dealer will be available to answer any questions you may have.

TFT LCD Displays

The colors of the display may seem to vary when viewed against a colored background or in colored light. This is a perfectly normal effect that will be seen with all color LCD displays.

In common with all Thin Film Transistor (TFT) LCD displays, the screen may exhibit a few (less than 20) wrongly illuminated pixels. These may appear as black pixels in a light portion of the screen, or as colored pixels in black areas.

CAUTION:

To provide protection against the damaging effects of UV light, it is advisable to replace the sun cover provided when the color LCD display is not in use.

Warranty

To register your *hsb²* series display unit ownership, please take a few minutes to fill out the warranty registration card found at the end of this handbook. It is very important that you complete the owner information and return the card to the factory in order to receive full warranty benefits.

EMC Conformance

All Raymarine equipment and accessories are designed to the best industry standards for use in the recreational marine environment.

The design and manufacture of Raymarine equipment and accessories conform to the appropriate Electromagnetic Compatibility (EMC) standards, but correct installation is required to ensure that performance is not compromised.

Contents

Preface	v
Warranty	vi
EMC Conformance	vi
Chapter 1: Overview	1.1
How to Use This Handbook	1.1
1.1 General	1.4
Introduction to <i>hsb2</i> Systems	1.4
PLUS Display Units	1.5
Operating Modes	1.6
Heading and Position Data	1.9
1.2 The Pathfinder Radar PLUS Display	1.10
Pathfinder Radar PLUS Display Options	1.10
Radar Functions	1.12
1.3 The Chartplotter Display	1.13
Chartplotter Display Options	1.14
Chartplotter Functions	1.15
1.4 Operating Controls	1.16
Trackpad and Cursor	1.16
Dedicated Keys	1.18
Soft Keys	1.18
Pop-Up Menus	1.19
Database Lists	1.20
Chapter 2: Getting Started & Adjusting the Display	2.1
2.1 Introduction	2.1
Conventions Used	2.1
Simulator	2.1
2.2 Switching the Display On and Off	2.2
Simulator Mode	2.5
Changing the Brightness	2.6
2.3 Controlling the Display	2.7
Selecting the Mode of Operation	2.7
Customizing the Screen Presentation Options	2.13

- 2.4 Radar Display Control Functions 2.16
 - Using the Zoom Function 2.16
 - Offsetting the Center 2.17
 - Hiding the Ship’s Heading Marker (SHM) 2.18
- 2.5 Chart Display Control Functions 2.19
 - Moving Around the Chart 2.19
 - Radar/Chart Overlay 2.23
- 2.6 Typical Chart Scenarios 2.25
 - Place and Goto a Waypoint 2.26
 - Make and Follow a Route 2.28
 - Review Your Passage Plan 2.30
 - Displaying the Radar and Synchronizing Radar & Chart 2.32

Chapter 3: Standard Radar Operations3.1

- 3.1 Introduction 3.1
- 3.2 Range Control 3.2
 - Changing the Range 3.2
 - Determining Actual Radar Range 3.3
- 3.3 Interpreting and Adjusting the Radar Picture 3.4
 - Identifying False Echo Returns 3.5
 - Adjusting Gain, Sea Clutter, Rain Clutter and Tune 3.7
 - Changing the Targets Display3.11
- 3.4 Measuring Range and Bearing Using VRM/EBLs 3.13
 - Measuring Range and Bearing to Target from Vessel 3.14
 - Measuring Range and Bearing Between Targets (FLOAT) 3.16
 - Controlling VRM/EBL Data Boxes 3.18
- 3.5 Setting Guard Zones and Alarms 3.19
 - Placing a Guard Zone 3.20
 - Moving, Reshaping or Deleting a Guard Zone 3.21
 - Controlling Guard Zone Alarms 3.22
- 3.6 MARPA 3.23
 - Introduction to MARPA 3.23
 - Using MARPA 3.25

Chapter 4: Integrated Radar Operations	4.1
4.1 Introduction	4.1
4.2 Changing the Heading Mode	4.2
True and Relative Motion	4.2
4.3 Using Marks	4.4
4.4 Man Overboard (MOB)	4.5
4.5 Cursor Echo	4.6
Chapter 5: Standard Chart Operations	5.1
5.1 Introduction	5.1
5.2 Using Chart Cards	5.2
Inserting a Chart Card	5.2
Removing a Chart Card	5.3
Displaying the Chart Data	5.3
Displaying Object Information	5.4
5.3 Working with Waypoints	5.8
Introduction	5.8
Placing a Waypoint	5.9
Selecting a Waypoint	5.12
Waypoint Data Display	5.12
Editing the Waypoint Details	5.13
Erasing a Waypoint	5.14
Moving a Waypoint	5.14
Using the ST60 or ST80 Navigator Keypad	5.15
5.4 Working with Routes	5.18
Creating a New Route	5.19
Saving the Current Route	5.22
Clearing the Current Route	5.23
Retrieve a Route From the Database	5.23
Displaying Route Information	5.24
Using the Route List to Erase and Name a Route	5.26
Editing a Route	5.27
5.5 Following Routes and Going to Points	5.30
Follow a Route	5.30
Target Point Arrival	5.32
Other Follow Route Options	5.32

Going To an Individual Target Point	5.33
Stop Follow or Stop Goto	5.34
5.6 Transferring Waypoints and Routes	5.35
5.7 Using Tracks	5.38
Setting Up a Track	5.39
Clearing the Current Track	5.40
Managing Tracks	5.41
SmartRoute	5.42
Chapter 6: Further Chart Operations	6.1
6.1 Introduction	6.1
6.2 Measuring Distances Using the VRM/EBL Key	6.2
6.3 Alarms and Timers	6.4
Alarm Reporting	6.4
Setting Alarms and Timers	6.5
6.4 Man Overboard (MOB)	6.6
6.5 Cursor Echo	6.7
6.6 GPS Setup	6.8
6.7 Data Log Mode	6.10
Chapter 7: Setting Up the System Defaults	7.1
7.1 Introduction	7.1
7.2 Changing the Set Up Parameters	7.2
7.3 System Set Up Parameters	7.4
Data Boxes	7.6
Bearing Mode	7.6
Cursor Reference	7.6
Cursor Readout	7.6
Day/Night	7.7
Help	7.7
Soft Keys	7.7
Key Beep	7.7
MOB Data	7.7
Menu Timeout Period	7.7

Units	7.7
Variation Source	7.8
Bridge NMEA Heading	7.8
NMEA Out Set Up	7.9
Cursor Echo	7.9
Date and Time Settings	7.9
GPS SOG/COG Filter	7.10
Compass Set Up	7.10
Language	7.10
Simulator	7.10
7.4 Radar Set Up Parameters	7.11
EBL Display	7.11
Timed Transmission Option	7.12
Marks Options	7.12
Custom Scale	7.12
Bearing Alignment	7.13
Antenna Size	7.13
Send on HSB	7.13
7.5 MARPA Set Up Parameters	7.14
7.6 Advanced Settings	7.15
Display Timing	7.15
STC Preset	7.16
Tune Preset	7.16
7.7 Chart Set Up Parameters	7.17
Customize Chart	7.17
Plotter Mode	7.18
Chart Orientation	7.18
Object Information	7.19
Waypoint Options	7.19
Vectors	7.19
Radar/Chart Synch	7.19
Datum Selection	7.19
Position Offset	7.20
Chapter 8: Installation	8.1
8.1 Introduction	8.1
Planning the Installation	8.2
EMC Installation Guidelines	8.2

8.2	Unpacking and Inspecting the Components	8.4
8.3	Selecting the Display Unit Location	8.5
8.4	Cable Runs	8.8
	Power Cable	8.8
	Inter-Unit Scanner Cable	8.9
	<i>hsb²</i> Cable	8.9
8.5	Mounting the Display Unit	8.10
8.6	System Connections	8.12
	Display Unit Connection	8.13
8.7	Radar System Tests and Installation Alignment	8.16
	System Check	8.16
	Switch On and Initial Setup	8.16
	Radar System Checks and Adjustments	8.17
	EMC Conformance	8.20
8.8	Integrated Systems	8.21
	<i>hsb²</i> TM (High Speed Bus) Multiple Display Systems	8.21
	SeaTalk® and NMEA In	8.24
	Using the SeaTalk Auxiliary Junction Box	8.29
	Data Output	8.30
	Data Conversion	8.30
8.9	Integrated System Checks	8.31
	Chart Display -RL70/80CRC PLUS, RC530 PLUS, RC631 PLUS ..	8.31
	Received Data	8.31
	Transmitted Data	8.31
Chapter 9: Maintenance and Problem Solving		9.1
9.1	Maintenance	9.1
	Routine Checks	9.1
	Cleaning Instructions	9.1
	EMC Servicing and Safety Guidelines	9.1
9.2	Resetting the System	9.3
9.3	Problem Solving	9.4
	Technical Support:	9.4
	How to Contact Raymarine (US)	9.5
	How to Contact Raymarine (Europe)	9.6
	Worldwide Support	9.6

Appendix A: Specification	A.1
<i>hst</i> ² Series 7" and 10.4" LCD Color Displays	A.1
Appendix B: Using the Auxiliary Junction Box	B.1
Raystar 112, 105, Apelco 182 and 182XT	B.2
Raystar 120 WAAS Satellite Differential Receiver	B.6
Appendix C: C-MAP Chart Card Features	C.1
Appendix D: SeaTalk and NMEA Data Received and Transmitted	D.1
Appendix E: Connecting a Raymarine Heading Sensor	E.1
G-Series Course Computer	E.1
Appendix F: Abbreviations	F.1
Index	1.xv

Chapter 1: Overview

How to Use This Handbook

This handbook describes the following *hsb²* (PLUS) series displays and multi-display systems:

RL70C PLUS Pathfinder Radar, 7" Color LCD Display

RL70CRC PLUS Pathfinder Radar & Chartplotter, 7" Color LCD Display

RC530 PLUS Chartplotter, 7" Color LCD Display

RL80C PLUS Pathfinder Radar, 10.4" Color LCD Display

RL80CRC PLUS Pathfinder Radar & Chartplotter, 10.4" Color LCD Display

RC631 PLUS Chartplotter, 10.4" Color LCD Display

If you are installing the display system yourself, you should read *Chapter 8* before you start the installation. This chapter also provides information that will be useful if you are connecting your *hsb²* series system to other equipment.

For an overview of *hsb²* (PLUS) display systems, the display unit controls and the radar/chartplotter systems, read *Chapter 1*. *Chapter 2* will help you start using your system.

For detailed information on radar operations refer to *Chapter 3: Standard Radar Operations* and *Chapter 4: Integrated Radar Operations*.

For chartplotter operating details, refer to *Chapter 5* and *Chapter 6*.

To change the system set up defaults, read *Chapter 7*.

Details for installing a radar scanner are provided in the *Radar Scanner User's Handbook* supplied with your scanner.

Note: *Many illustrations in this handbook show example screens. The screen you see on your display depends on your system configuration and set up options, so it may differ from the illustration.*

This handbook is organized as follows:

Chapter 1 provides an overview of an *hsb²* multi-display system and the features and functions of the *hsb²* PLUS series LCD Color Display. This chapter also provides an overview of the controls. You should read this chapter to familiarize yourself with the system.

Chapter 2 explains how to start using the display and describes how to use some of the basic radar and chart functions. Chapter 2 also provides operating guidelines for typical chartplotter scenarios; these guidelines introduce you to many of the chartplotter functions.

Chapter 3 provides detailed operating information for the main radar functions - adjusting the radar picture; measuring distances and bearings; setting guard zones and alarms, using MARPA for target tracking.

Chapter 4 provides detailed operating information for integrated radar system functions, including using marks, man overboard and cursor echo.

Chapter 5 provides detailed operating information for the standard chartplotter functions - using chart cards, plotting waypoints and routes, following routes and showing tracks.

Chapter 6 provides detailed operating information for further chart functions, including measuring distances, man overboard and cursor echo. It includes instructions for setting up a differential GPS.

Chapter 7 provides instructions for setting up your system to suit your preferences. You should read this chapter to determine how to set up the radar and chartplotter system defaults.

Chapter 8 provides planning considerations and detailed instructions for installing the display unit(s). It should be referred to when you are ready to install the system. Details to connect the display to other equipment are also provided. To install a complete radar system, you will also need to read the Owner's Handbook supplied with the scanner.

Chapter 9 provides information on user maintenance, and what to do if you experience problems.

The Appendices provide additional information that you may find useful:

Appendix A lists the technical specifications for the radar and chartplotter.

Appendix B provides details on connecting the display unit to specific GPS systems.

Appendix C defines the chart features shown on the chart display.

Appendix D defines the SeaTalk and NMEA data that is transferred on integrated systems.

Appendix E provides details on connecting a Raymarine heading sensor for MARPA and radar/chart overlay.

Appendix F provides a list of abbreviations.

An Index and warranty information are included at the end of the handbook.

A summary of the radar and chartplotter controls are provided on the Quick Reference Cards supplied with your system.

Terminology

The following terminology is used to describe radar and chartplotter systems:

- Master** A unit capable of sourcing specific data such as fishfinder, chart or radar data.
- Repeater** A unit capable of displaying data, such as radar, from *hsb²*.
- Fishfinder Display** Unit providing Fishfinder Master, Chart Repeater and Radar Repeater functionality.
- Radar Display** Unit providing Radar Master, Fishfinder Repeater and Chart Repeater functionality.
- Chart Display** Unit providing Chart Master, Fishfinder Repeater and Radar Repeater functionality.
- Combined Display** Unit providing both Radar and Chart Master or Fishfinder and Chart Master functionality.
- Integrated System** Additional instruments are connected via *hsb²*, Seataalk or NMEA interfaces.
- hsb²*TM High Speed Bus - links compatible display units. It supersedes HSB and allows multiple display systems. For full display and control between *hsb²* series display units, the units must be connected via *hsb²* **and** SeaTalk.

1.1 General

The *hsb²* (PLUS) series Pathfinder Radar or Pathfinder Radar/Chartplotter comprises the 7" or 10.4" Color LCD PLUS display unit, scanner unit and associated cables. The RC530 PLUS and RC631 PLUS Chartplotters cannot be connected to the scanner unit.

Display Unit

The *hsb²* (PLUS) series display unit is waterproof to CFR46 and can be installed either above or below deck.

The unit includes:

- 7" or 10.4" color LCD PLUS display
- Trackpad
- Eleven dedicated (labeled) control keys
- Four soft keys (unlabeled) whose functionality changes
- Two slots for the C-MAP NT[®] chart cards

The display and keys can be illuminated for night-time use.

Scanner

The *hsb²* series Pathfinder Radar is supplied with a scanner unit which illuminates targets with microwave energy and then collects the returns from those targets. The scanner includes a sensitive low-noise front end receiver, and a variety of clutter attenuation controls to maintain target resolution.

Installation of the scanner is described separately in the Scanner Owner's Handbook. The scanner is adjusted and operated from the display unit, so these details are provided in this Handbook.

The scanner can be switched between transmit and stand-by modes. It also has a power-saving timed transmit mode which pauses between bursts of transmissions.

Introduction to *hsb²* Systems

It is possible to connect up to ten *hsb²* (PLUS) series LCD or CRT displays (dependent on cable lengths) and a scanner unit to provide an integrated system. The system may include existing HSB display units that have been suitably upgraded - contact your authorized Raymarine dealer for upgrade kit details.

The *hsb²* (High Speed Bus) connection enables transfer of data between compatible units. For example, radar data is transferred from the radar (the

master display) via the *hsb²* connection and can be displayed *and controlled* on any other *hsb²* series LCD or CRT display (the repeater display).

In particular, you can connect your Radar to a remote Chartplotter (or Fishfinder/Chartplotter) to provide similar functionality to the combined Radar/Chartplotter (or Fishfinder/Chartplotter). However, you should be aware that if you change, say, radar range on one display, it affects all displays showing radar (or radar/chart overlay on color displays).

The *hsb²* system can include several chartplotter displays, each with two chart cartridge slots. Each display can access two local and up to six remote chart cartridges. Charts can be controlled *independently* on each display, even when a remote chart cartridge is being used.

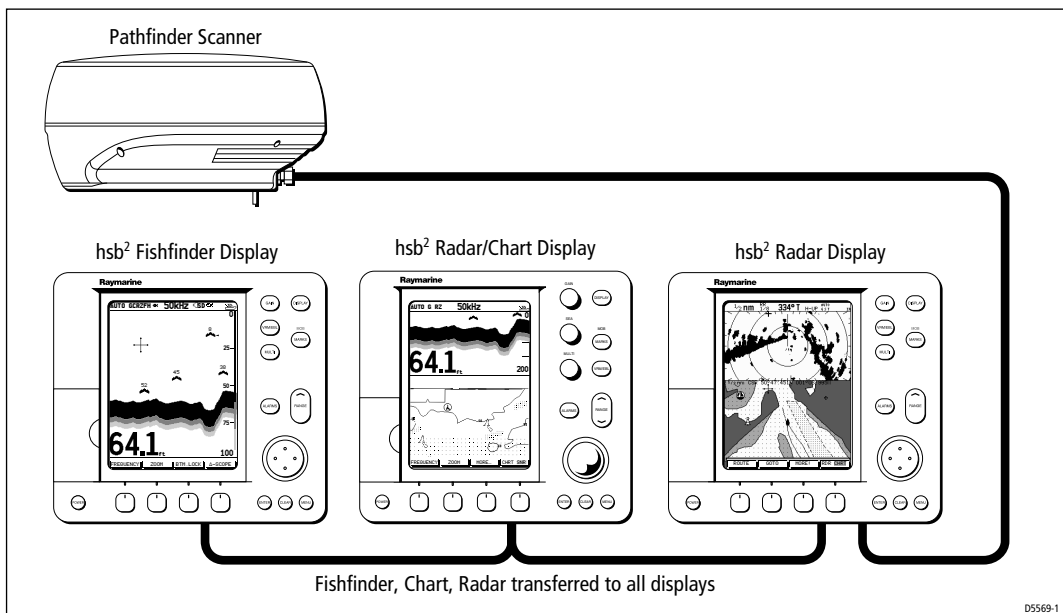

Figure 1-1: *hsb²* Integrated System

PLUS Display Units

Features

- Chartplotter – Displays chart information from the C-MAP NT® chart cards (C-Cards)
- Uses position data from GPS, DGPS, WAAS or Loran-C technology
- Displays and transfers SeaTalk, NMEA and *hsb²* data
- Provides full control of data from other *hsb²* instruments
- Several full-screen operating modes including Radar, Chart, Data Log or Sonar, if appropriate data is available.

- View radar and chart simultaneously as radar/chart overlay or in half-screen windows.
- Half-screen windows to display additional data: Course Deviation Indicator (CDI), Bearing and Distance Indicator (BDI), navigation data.
- Cursor echo across SeaTalk, and between chart and radar windows
- Choice of orientation: Head Up, Course Up and North Up
- The system can be connected to an ST80 Navigator keypad for entry of alpha-numeric data.

Set Up Options

Set up options allow you to choose what is displayed, how it is displayed (including language and units), bearing mode and how the display operates with other *hsb²* units. You can view the cursor position and a variety of data from other equipment, e.g. speed, heading, depth, wind and tide information in a set of user-selectable data boxes.

Display options are provided in System Set Up, described in *Chapter 7*. Screen Presentation Options, described in *Chapter 2* allow you to switch the cursor and data boxes On/Off. The cursor box and user-selected data boxes can be moved around the screen

Operating Modes

On a *single hsb²* unit you can view a full screen radar or chart and, on a combined unit, you can overlay the radar targets on to the full screen chart. You can also set *Windows On* to split the display into two half-screen windows to show supplementary data or, on a combined display unit, display radar and chart simultaneously. The main operating mode (radar or chart) is displayed in the upper window; you choose what is displayed in the lower window.

The following are available:

Table 1-1: *hsb²* Single Display Operating Modes and Window Options

Display	Full-screen mode	Half-screen Window Options
RL70C PLUS, RL80C PLUS	Radar	CDI, BDI or Nav Data
RC530 PLUS, RC631 PLUS	Chart	CDI, BDI or Nav Data
	Data Log	Windows not available
RL70CRC PLUS, RL80CRC PLUS	Radar Mode	CDI, BDI, Chart or Nav Data
	Chart Mode	CDI, BDI, Radar or Nav Data
	Radar/Chart Overlay Data Log Mode	Windows not available

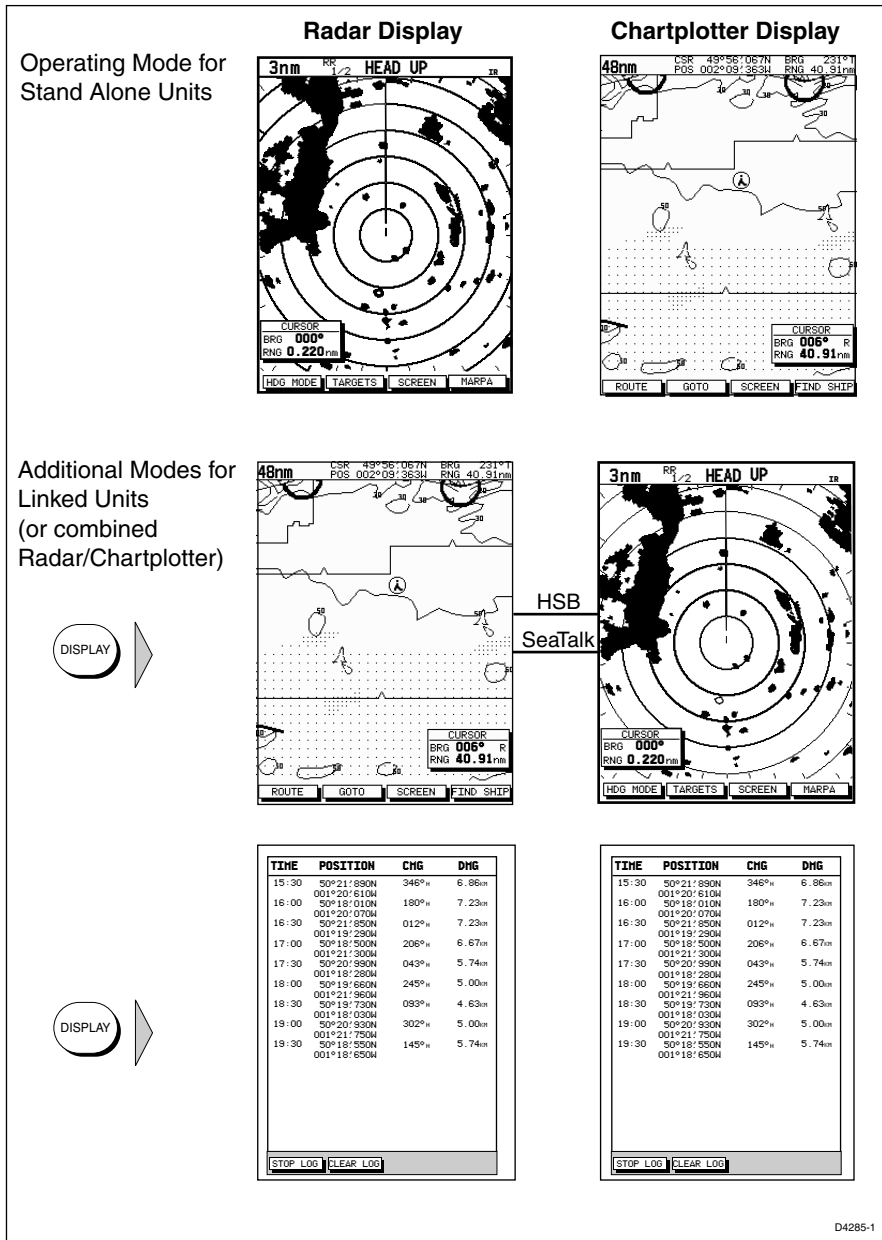

D4285-1

Figure 1-2: Full Screen Operating Modes

Half-Screen Window Options

- **Chart display, Radar display:** If data is available as a function of the combined display unit it can be displayed full screen, as shown in *Figure 1-2*, or in a half-screen window.
- **CDI:** This gives the Course Deviation Indicator graphical display, with data relating to the target waypoint.
- **BDI:** This gives the Bearing and Distance Indicator graphical display, with data relating to the target waypoint.
- **Nav Data:** This shows sixteen data boxes, providing navigational data in the units specified in your set up. Note that up to 6 of these data boxes are also available as a *user-selectable group* (see *Section 7.3*).

You select the operating mode and windows using the **DISPLAY** key as described in *Chapter 2*.

Multi-display systems

If you have several *hsb²* series Radar and Chartplotter displays connected operation is similar to a combined Pathfinder Radar/Chartplotter Unit: threefour full-screen modes –radar, chart, radar/chart overlay and data log are available on *all* displays.

In addition, if you have an *hsb²* series Fishfinder display connected, you can set any display to fishfinder mode; if the system includes a chartplotter, similar functionality to a combined Fishfinder/Chartplotter is available on all displays.

On an *hsb²* system with Radar, Chart and Fishfinder available, the following information can be shown on any display unit:

Table 1-2: Window Options for Integrated Systems

Full-screen mode	Half-screen Window Options
Chart Mode,	CDI, BDI, Nav Data, Fishfinder or Radar
Radar Mode	CDI, BDI, Chart or Nav Data
Fishfinder Mode	Depth/temp, Chart or CDI, BDI
Radar/Chart Overlay	Windows not available
Data Log Mode	Windows not available

For details on the fishfinder, refer to the *hsb² Series Display Owner's Handbook* supplied with your fishfinder.

Heading and Position Data

Full functionality of the radar/chartplotter is achieved when it is part of an integrated system with other equipment (in addition to another *hsb²* unit) connected via SeaTalk or NMEA 0183. Data from this equipment including position and heading is shown on the display and is used in calculations.

Details on connecting other equipment are given in *Chapter 8*.

Providing Heading Data for Radar/Chart Overlay and MARPA

The performance of MARPA and Radar/Chart Overlay is dependent on the quality of your heading sensor. It is important that both the heading sensor and the radar scanner (bearing alignment) are correctly calibrated. Refer to the appropriate heading sensor and radar scanner handbooks for calibration details. The better the accuracy of your heading data, the better the performance of MARPA and Radar/Chart Overlay.

A gyro compass provides the best performance in all conditions. Alternatively you could use a fluxgate compass with rate gyro stabilization.

MARPA requires heading data to be frequently updated (we recommend a data output rate of greater than 8 Hz); heading data must therefore be provided on NMEA.

In multiple-display systems, heading must be connected, via NMEA, to each display that will be used for MARPA.

We recommend the Raymarine Rate Gyro Compass system. Good results are also obtained with a Raymarine autopilot system incorporating a 150G or 400G Course Computer with internal rate gyro.

Other heading sensors connected on NMEA *may* provide satisfactory results in reasonable sea states. However, in unsettled conditions a rate gyro compass is advisable.

Contact Raymarine Customer Services or your authorized Raymarine dealer for additional information. For specific configuration details with the Raymarine course computer refer to *Appendix E*. If you are using a suitable third party heading sensor, refer to its documentation for installation and calibration details.

1.2 The Pathfinder Radar PLUS Display

When a scanner is connected and the radar is in Transmit mode, the radar picture provides a map-like representation of the area in which the radar is operating. Typically, your ship's position is at the centre of the display, and its dead ahead bearing is indicated by a vertical heading line, known as the Ship's Heading Marker (SHM).

The radar picture can be viewed with a variety of fixed or customised range scales. The colour of the radar returns (echoes) indicates their intensity: the strongest returns are shown in yellow and the weaker are shown in shades of blue. A status bar at the top of the radar image displays range, current heading and mode indicators for the various options you can set.

An example radar picture is shown on the next page, with example radar returns (echoes) and default Pathfinder Radar information. The Status Bar is also illustrated.

The radar display can show additional information, depending on your currently selected options, set up selections and the data available from other equipment. The example displays on the following pages show some of these features.

Functions are available to control the display as follows:

- Zoom the Display
- Offset your vessel from the centre of the radar picture

Operation of these functions is described in *Chapter 2*.

Pathfinder Radar PLUS Display Options

In addition to the display set up options previously described, radar set up options allow you to customise the radar image by selecting how radar marks and Electronic Bearing Line (EBL) data are displayed. You can also specify timed transmit mode and custom range scales.

The Screen Presentation Options, described in *Chapter 2* allow you to switch range rings on/off and waypoint display on/off.

Note: *When you turn the display off and on again, the Screen Presentation settings are retained in memory.*

Default Display

Targets:

- Landmass
- Channel buoy
- Surface vessel

Status Bar

- Range rings**
The number and spacing depend on the current range, or you can turn them off
- Ship's Heading Marker (SHM)**
You can hide this temporarily
- Cursor position**, controlled by the trackpad
- Ship's position**
You can move this off-centre if required
- Bearing scale**, each tick indicating 2° of azimuth
- Cursor position box**
Shows the current cursor position as either Range/Bearing or Lat/Long. You can move this box to your preferred position on the screen, or turn it off.

Default soft key labels
These can be turned off; press any soft key to re-display them. Different labels are displayed when you press a key.

D3600-6

Status Bar

Selected range, in nautical miles		Range rings (displayed if rings are on)	Motion Mode Relative Motion True Motion	Target Vectors True Vector or Relative Vector and vector length	Auto mode Gain, Sea, Tune	Wakes	Target Expansion Guard Zone Alarms
3nm	RINGS 1/2	126°T	RM RV3 H-UP	AUTO GST	WKS FTC	EX RC	GZ IR
Range ring interval Not displayed if range rings are off	Current heading if data available, or Course Over Ground. Displayed in degrees Magnetic or True	Heading mode Normally Head Up (H-UP); Course Up (C-UP) or North Up (N-UP) can be selected if heading data available	FTC (Remote rain)	Rain Clutter	Interference Rejection		

Mode Indicators
displayed when function on:

D3993-2

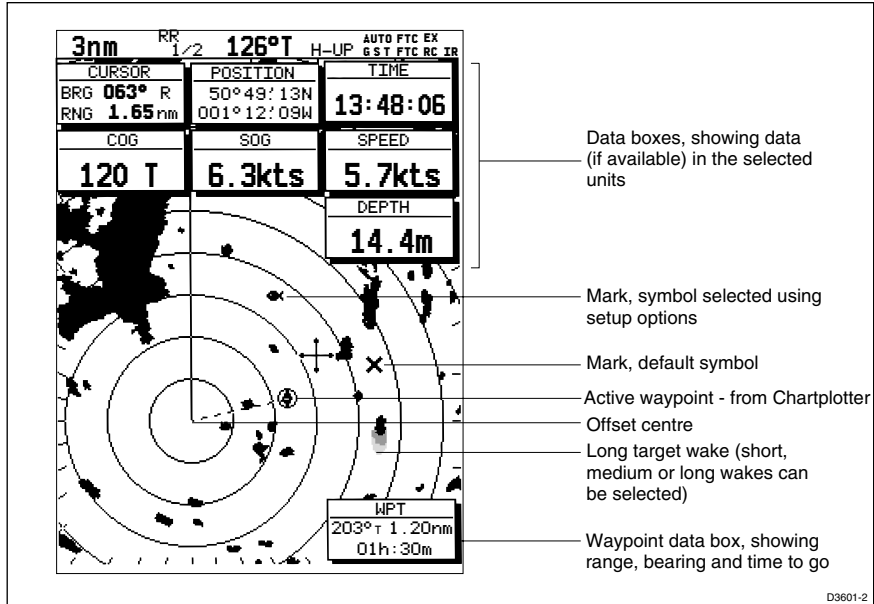

Radar Functions

The *hsb²* (PLUS) series Pathfinder Radar includes the following functions:

- Choice of range scales from $\frac{1}{2}$ nm to 72nm (dependent on scanner type).
- Automatic and manual control of tuning, gain and sea clutter.
- Two Variable Range Markers (VRMs) and Electronic Bearing Lines (EBLs), allowing target range and bearing measurements. VRM/EBLs can be floated.
- Target wakes and target expansion mode.
- Two guard zones with alarms.
- Add marks to record important or dangerous locations.
- Man Overboard (MOB) to navigate back to a person or object.
- 10 Target MARPA

Operation of these radar functions is described in *Chapter 3* and *Chapter 4*.

1.3 The Chartplotter Display

The *hsb²* (PLUS) series LCD Display can include a Chartplotter. The chartplotter includes a small-scale world map and detailed navigation information is displayed when a cartographic chart card is installed. The details displayed depend on the chart zoom level selected. A plotter mode is provided to enable route plotting and tracking at large scales even when a chart card is not installed, or when the chart is zoomed beyond the available cartographic detail. A typical chartplotter screen is shown in *Figure 1-3*.

The chartplotter uses position information from a GPS, DGPS, WAAS or Loran-C instrument. Once the position fix has been established, your vessel's position, if on screen, is shown as a boat shape pointing in the direction of the current heading (or COG if heading data is not available). If no heading or COG data is available, the vessel is shown as a circle.

The chartplotter screen includes a status bar that displays chart scale, with either cursor position, range and bearing or, when the cursor is homed to the vessel (by pressing FIND SHIP), vessel position, Speed Over Ground (SOG), Course Over Ground (COG) and fix type (VES POS, DIF FIX or SD FIX). The status bar also indicates if radar/chart overlay is switched on.

Any waypoints you have placed are displayed (unless you turned them off in Chart Set Up as described in *Chapter 7*) and the current route is shown. Information can be viewed on-screen by positioning the cursor over a waypoint, current route or chart object. The chartplotter screen can also show additional information, depending on your currently selected options, set up selections and data available from other equipment.

An example chart display, in its default configuration, with a chart card installed, is shown in the following illustration.

Several functions are available to control the display as follows:

- Zoom in/out and Pan the Display
- Offset the Chart or Center the Chart around the Vessel
- Overlay Radar Targets onto the Chart Display
- Synchronize the Chart and Radar (if radar data is available)

Operation of these functions is described in *Chapter 2*.

Chartplotter Display Options

In addition to the display set up options previously described, chart set up options, described in *Chapter 7*, allow you to customize the chart by selecting:

- What cartographic features and level of detail are displayed.
- Chart orientation (north up, head up or course up), datums and position offset.
- How waypoints are displayed (symbols and numbers).
- Vectors for heading, COG and tide.

The Screen Presentation Options, described in *Chapter 2* allow you to switch the Chart Grid On/Off and Custom Chart Details On/Off.

Note: When you turn the display off and on again, the Screen Presentation settings are retained in memory.

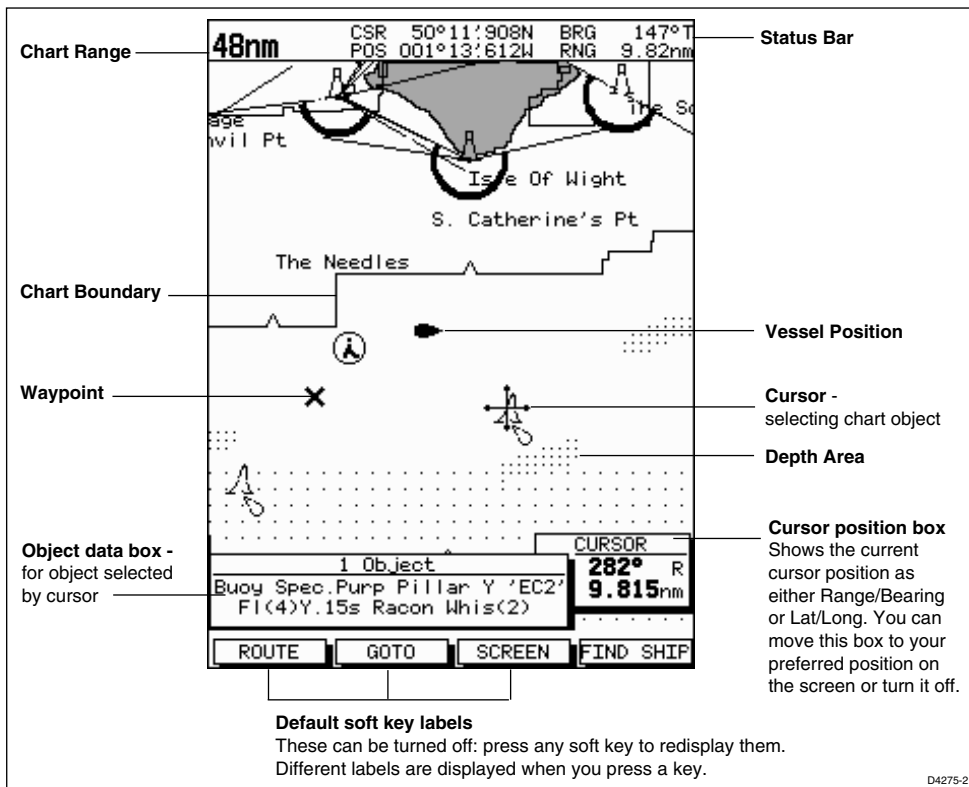

Figure 1-3: Typical Chartplotter Display

Custom Chart Details

The chartplotter set up options include a sub-menu to customize the cartographic features. This menu allows you to switch features On, Off, or control them using the CUSTOM soft key. The factory default settings for the Custom chart options are as follows:

ON: Chart text, chart boundaries, depth contours, navigation marks and land features.

OFF: Caution and routing data.

CUSTOM: Spot sounding, light sectors, marine features.

Note: *The factory default for the CUSTOM settings is ON.*

Icons are displayed in detail, depth shading limit is 10 m and depth contour display is 0-100 m.

A complete list of chart features is given in *Appendix C*.

Chartplotter Functions

The *hst²* (PLUS) series Chartplotter includes the following functions:

- Display C-MAP NT C-Card chart information including Ports and Tides (if available)
- View chart information (if available) for the Nearest Port
- Place, Move, Erase and Edit a Waypoint
- Goto Waypoint or Cursor
- Create, Save, Name, Edit and Follow a Route
- Review Route and Waypoint Lists
- Display vessel's track; Save and Name the Track for re-call to screen
- SmartRoute to make a track into a route
- Measure Chart Distances and Bearings on-screen
- Set Up Alarms and Timers
- Man OverBoard (MOB) to navigate back to a missing person or object
- Differential GPS set up page

Operation of these functions is described in *Chapter 5* and *Chapter 6*.

1.4 Operating Controls

You operate the radar and chart systems using a variety of controls:

- A trackpad providing up, down, left, right and diagonal control of an on-screen cursor.
- Eleven dedicated (labeled) control keys.
- Four soft keys with labels displayed on the screen.
- Pop-up menus, displayed on-screen, from which you select options.
- Database lists, displayed on-screen, which enable you to edit items.

Note: *The cursor is the cross-hair symbol (+) visible on the display. You move the cursor using the trackpad and use it to select a position or item on the chart.*

The control keys are shown in *Figure 1-4*. They are back-lit for night-time use. When you use a control, a help message is displayed at the top of the screen (unless you switch help off as described in *Chapter 7*). The following paragraphs describe the controls and on-screen facilities.

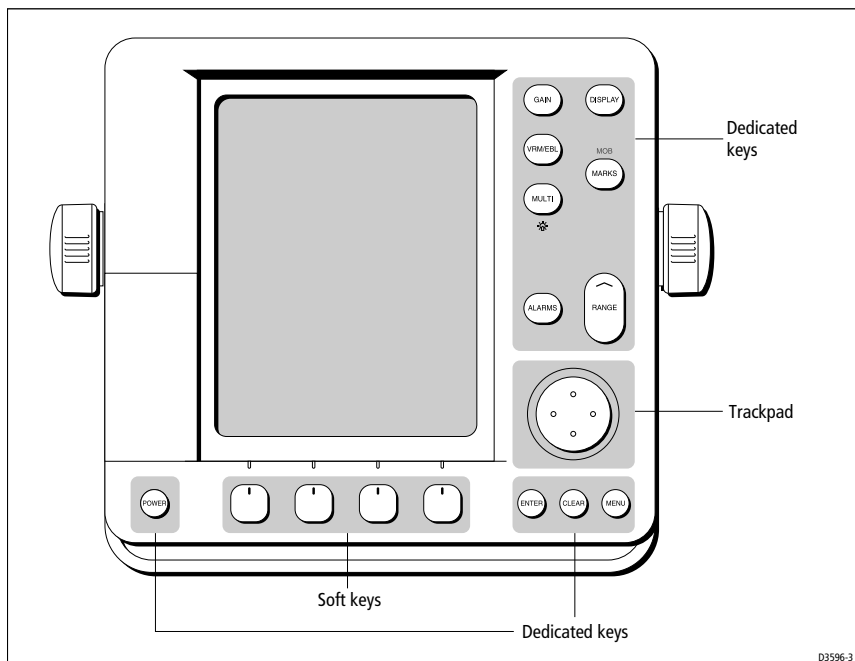

Figure 1-4: LCD Display Control Keys

Trackpad and Cursor

The trackpad has several functions:

- To move the cursor around the screen
- To select an item from a pop-up menu
- To adjust a variable soft key control

The cursor is used to:

- Select a position on the screen.
- Select an item, e.g. guard zone on the radar, chart object on the chartplotter.
- Select an area of the radar image to zoom into or pan the chart display.

Moving the Cursor

You can press on any of the four sections of the trackpad to move the cursor in that direction (up, down, left or right), or press two sections at the same time to move diagonally. The cursor moves faster as you continue to press the trackpad. The current cursor position is shown in the cursor data box (if selected).

Note: *During many operations you cannot move the cursor around the screen; if you cannot move the cursor using the trackpad, check the default soft keys are displayed (unless they have been switched OFF in system set up). If not, press **ENTER** until they are displayed.*

The cursor is normally displayed as a crosshair. However, if you have not moved the cursor for more than five seconds, when you next move it the cursor is outlined by a circle so it is easier to locate on the screen.

Context-Sensitive Cursor Control

The cursor is context-sensitive. When the cursor is positioned over special features on the display a text label appears to identify the feature as follows:

Table 1-3: Context-Sensitive Cursor Text Labels

Text Label	Feature	Radar/Chart
BOX	Data box (any type)	Both
MOB	Man Over Board marker	Both
MRK	Radar Mark	Both
WPT	Chart Waypoint	Both
CTR	Centre of radar	Radar
FLT	Floating EBL/VRM	Radar
GRD	Guard zone	Radar
MARPA	MARPA Target	Radar
SHM	Ships Heading Marker	Radar
VRM/EBL	VRM and EBL, 1 or 2	Radar
ZMB	Zoom box	Radar
A→B	Ruler line	Chart

Table 1-3: Context-Sensitive Cursor Text Labels

Text Label	Feature	Radar/Chart
COG	Course Over Ground vector	Chart
HDG	Heading vector	Chart
POS	Vessel's position	Chart
RTE	Route leg	Chart
TIDE	Tide vector	Chart

Some items on the radar/chartplotter screen, such as the cursor have information associated with them. Most information is displayed in a data box. The context-sensitive cursor allows you to move databoxes.

Dedicated Keys

The dedicated keys: **DISPLAY, MARKS, GAIN, VRM/EBL, MULTI, ALARMS, RANGE, ENTER, CLEAR, MENU** and **POWER** have fixed functions; the functions are similar on all *hsb²* series displays. For example, **ALARMS** is used to set up the system alarms on both a chartplotter and a radar.

Some keys can be used in two ways:

- **Press:** Press the key momentarily and then release it. This method is used for most key operations.
- **Press and hold:** Press the key and hold it down for the length of time stated (for example, 3 seconds), and then release it.

When you press a dedicated key, one of the following happens:

- The associated operation is actioned, e.g. change chart scale (**RANGE**).
- A pop-up menu is displayed, providing further options.
- A set of soft keys is displayed, providing further functions.

As you press a key, a single audio beep confirms the key action. If the key-press is not valid for the current screen or mode, three rapid beeps sound to indicate that no response is available. If required, you can turn the key beeps off as part of your set up procedure (see *Chapter 7*).

Soft Keys

The four keys below the screen are called soft keys because their functions change according to the operation. The soft keys are grouped into related sets and subsets providing access to the various functions. The soft key labels are displayed on the screen just above the keys. The default soft keys are displayed

until you press a key, or select an item on the screen; the soft keys associated with the action are then displayed.



The currently selected soft key option is shown by its green background. If the key text is displayed in gray rather than in black, it is not currently available.

When you press a soft key one of the following happens:

- i. The associated operation is actioned, e.g. NORTH UP.
- ii. A sub-set of soft keys is displayed, providing further functions.
- iii. A pop-up menu is displayed, providing further options.

As with dedicated keys, when you press a soft key a single audio beep confirms the key action. If the key-press is not valid for the current screen or mode, three rapid beeps sound to indicate that no response is available. If required, you can turn the key beeps off as part of your set up procedure (see *Chapter 7*).

Pop-Up Menu

Pop-up menus usually provide set up options. When a pop-up menu is on-screen, a set of associated soft keys is also displayed as shown in *Figure 1-5*.

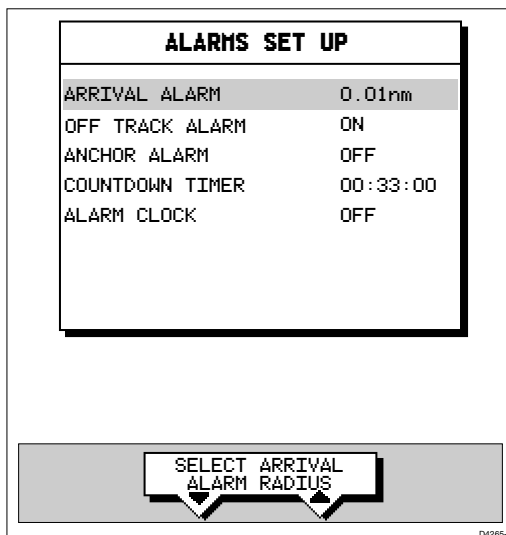

Figure 1-5: Typical Pop-up Menu

You use the trackpad to select an option from the menu, then use the appropriate soft key to set the option. For example, you can toggle the OFF TRACK ALARM on/off.

Database Lists

The waypoints, routes and tracks that you create on the chartplotter are stored in database lists. You can view these lists and select items for editing.

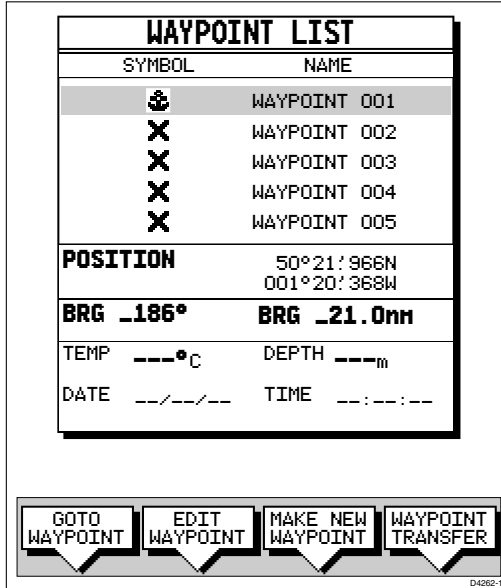

Figure 1-6: Typical Database List

As with pop-up menus, when a database list is on-screen, a set of associated soft keys is also displayed; you use the trackpad to select an item from the list, then use the appropriate soft key to edit the item. For example, you can erase a waypoint or a route.

Chapter 2: Getting Started & Adjusting the Display

2.1 Introduction

This chapter provides information and instructions to get you started using the *hsb²* series LCD display. It will help you to become familiar with the display and the functions of the controls before you start using the unit. More detailed information on operating the radar display is provided in *Chapter 3* and *Chapter 4*. Chartplotter operating details are given in *Chapter 5* and *Chapter 6*.

Conventions Used

Throughout this handbook, the dedicated (labelled) keys are shown in bold capitals; for example, **MENU**. The soft key functions, menu names and options are shown in normal capitals; for example, SCREEN.

Operating procedures, which may consist of a single key-press or a sequence of numbered steps, are indicated by a ► symbol in the margin.

When the procedure requires you to press a soft key, the soft key icon is shown in the margin.

Simulator

The display unit includes a simulator function, that allows you to practice operating your radar or Chartplotter without data from the scanner or GPS system. You will need to use the set up options to switch the display to simulator mode, as described in *Section 2.2*. You can use it in either of two ways:

- Before the display unit has been installed on your vessel. In this case, you only need to connect the display to a 12V or 24V DC power supply, connecting the red core from the power lead to positive (+) and the black core to negative (-). See *Chapter 8* for full details.
- After the display has been installed on your vessel, but while in the marina or at anchor.

The following section, *Section 2.2*, includes instructions to view simulated radar and chart images.

2.2 Switching the Display On and Off

If you have a combined Radar/Chartplotter, the factory default power-up mode is radar. Once you have used the display unit it powers-up in the last used mode. The following sections describe the power-up sequence in radar and chart modes, how to adjust the lighting and how to select simulator mode.

Radar Mode

This section explains how to switch the radar display and scanner on and off, and how to switch the scanner between Transmit, Standby and Scanner Off mode.

You normally operate your radar in transmit mode, but you can use the display unit without the scanner operating as follows:

Standby mode: You should use this mode when you are not operating the radar for short time periods. The scanner does not transmit and the antenna does not rotate, so the radar uses less power. However, the scanner remains powered so when you return to transmit mode, the magnetron does not need to warm up.

Scanner off mode: You should use this mode when you do not require the radar, but you are using the display unit say, for chart data or data from another source. Scanner off mode removes power from the scanner.

- To switch the display on, press and hold the **POWER** key until the unit beeps. If the unit was last used in Radar mode, the keys light up, the display shows the Pathfinder graphic, followed by the start-up information illustrated below, and the radar starts the magnetron warm-up sequence.

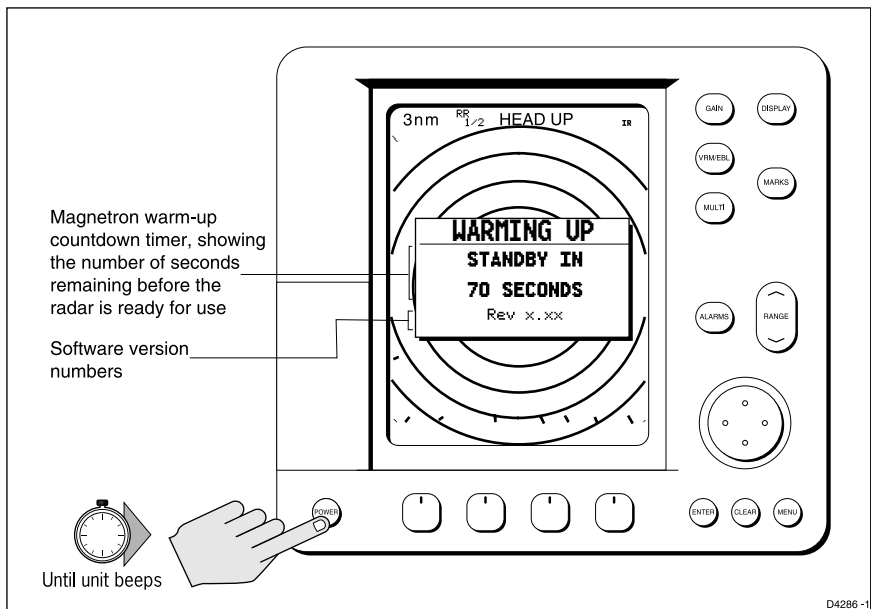

Figure 2-1: Switching on the Radar Display

After 70 seconds, when the magnetron warm-up sequence is complete, the Standby screen is displayed, with the text **STANDBY** and a prompt to press the **POWER** key to enter Transmit mode.

- To switch the radar scanner from Stand-by mode to Transmit mode, press the **POWER** key.

The scanner transmits pulsed energy while it rotates, and the antenna sweep builds up the radar picture using echoes returned from targets.

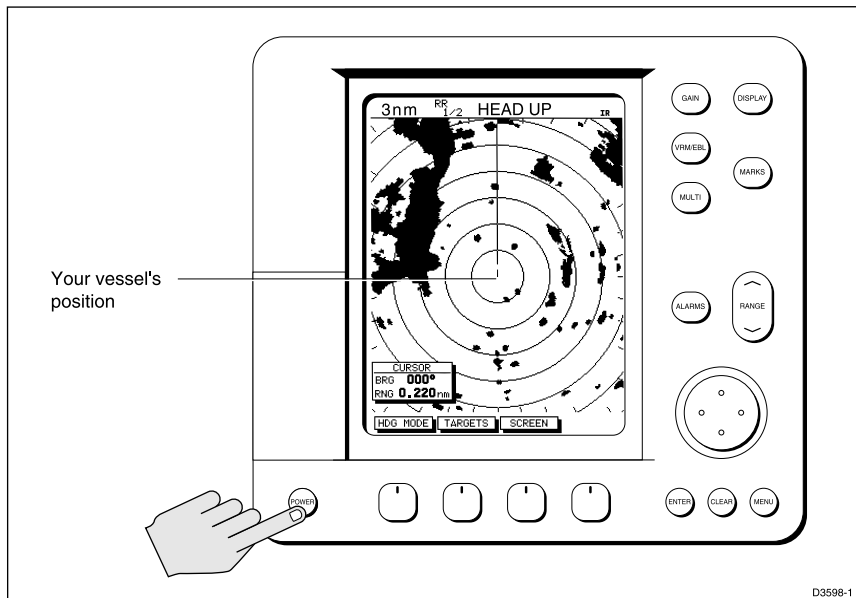

Figure 2-2: Radar Transmit Mode

- You can switch on and adjust the display backlighting, if required, as described later in this chapter.
- To switch to Stand-by mode, press the **POWER** key. The display returns to the Stand-by screen, and the scanner transmission and rotation stops.
- To use Scanner off mode:
 1. Ensure that the radar is in Standby mode, warming up, or (if the unit is a Repeater) displaying a message that radar data is not available.
 2. Press the **CLEAR** key. The message **STANDBY. RADAR DATA NOT AVAILABLE** appears in the radar picture. The scanner is powered down and the timer, if running, is cleared.

To return to radar operation, press the **POWER** key. The warm-up countdown is displayed and the radar goes into Standby mode. You press **POWER** again to switch to Transmit mode when required.

Chart Mode

- To switch the display on, press and hold the **POWER** key until the unit beeps. If the display was last used in chartplotter mode, the keys light up and the Raychart graphic is displayed, followed by the caution:

CAUTION:

Raychart chart displays are based on cartographic data that C-MAP believes to be accurate. However, you should not rely on these displays as your primary source of navigation. Rather, your Raychart should be used only as a backup to official government charts and traditional methods of navigation.

When you have read and understood the caution, press the CONTINUE soft key. The chart is displayed.

If this is the first time the chartplotter has been turned on, and no chart card is installed, the display shows the small-scale world map and the default soft keys. Otherwise, the display shows the selected chart area and any data that were displayed when the display was last used.

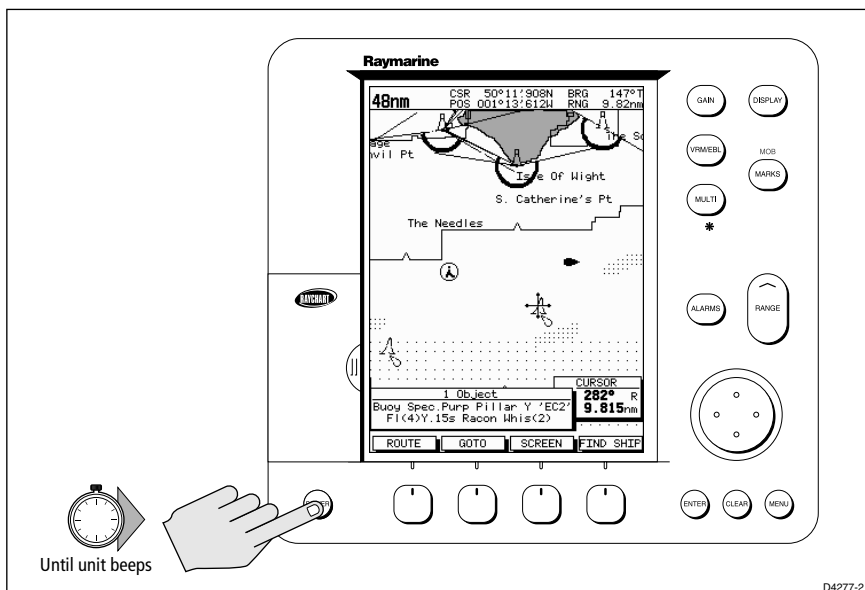

Figure 2-3: Switch On - Chart Mode

Switch Off

CAUTION:

To provide protection against the damaging effects of UV light, it is advisable to replace the sun cover provided when the color LCD display is not in use.

A reminder is displayed when you switch off the color LCD display.

- To switch the scanner and display unit off, press and hold the **POWER** key for three seconds. A countdown timer is displayed as shown below:

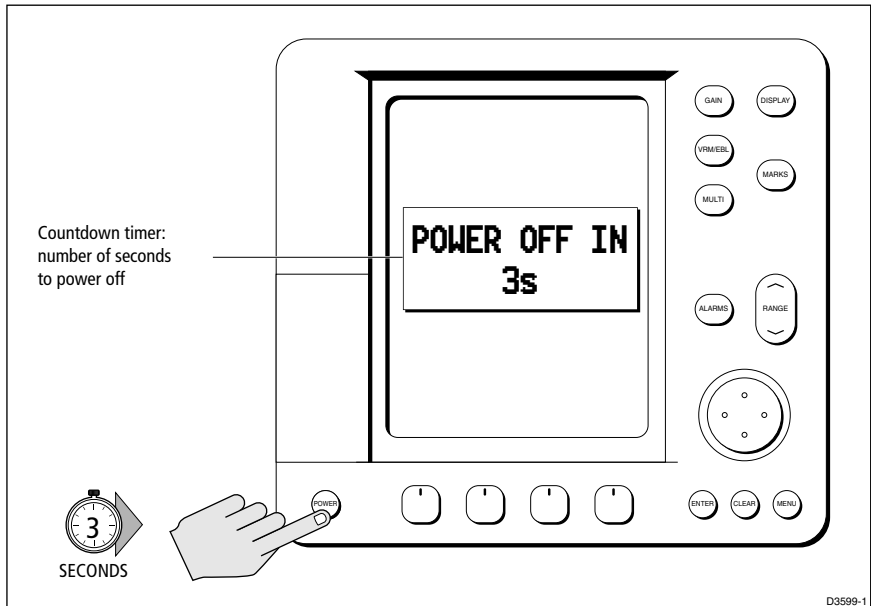

Figure 2-4: Switch Off

When the counter reaches zero a beep sounds, and the display unit switches off. Release the **POWER** key.

Note: Switch the display unit off before you remove the power cord.

Note: You do not need to change to Standby mode before turning off the display: if you turn the radar display off while it is in Transmit mode, the scanner is also de-activated.

Simulator Mode

When simulator mode is on a simulator data box is displayed.

When the display is switched off then on again, simulator mode is maintained. It is recommended that you select the System Set Up Menu and switch off simulator mode when you have finished.

► To view a simulated image:



1. Press **MENU** followed by the SYSTEM SET UP soft key. The set up menu pop-up is displayed.
2. Use the trackpad to move the selection bar over the option SIMULATOR. The simulator soft keys are displayed.
3. In the system set up menu, press RADAR to view a simulated radar image, DATA to view the chart display with simulated position, or BOTH to view simulated radar and chart data.
4. Press **ENTER** twice to return to the default display.

Note: Any waypoints placed on the chartplotter in simulator mode are retained in the database list and are available for use in routes.

Changing the Brightness

The **MULTI** key on the color LCD display is used to adjust brightness. The brightness of the screen can be adjusted over a wide range, suitable for viewing in daylight (high brightness level) or at night (low brightness level).

The key lighting is automatically adjusted as you alter the screen lighting, so that you can always find the keys. If you set the backlight to a high level, the key lighting is dimmed; if you set the backlight to a low level, the key lighting level is increased.

Adjusting the Brightness

➤ To change the screen brightness:

1. Press the **MULTI** key to display the soft key controls (Radar mode soft keys are illustrated):

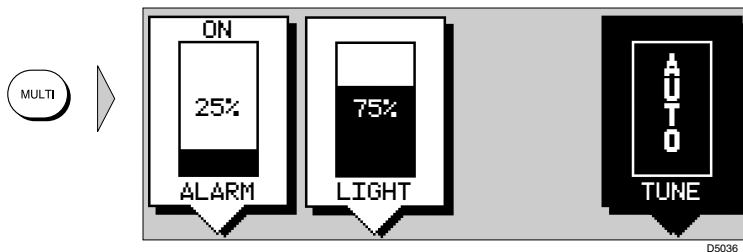

2. The **LIGHT** soft key indicates the brightness level, use the trackpad (up or down) to increase or decrease the setting. You can press and hold the trackpad to change the setting more rapidly. The brightness level is adjusted as you change the setting.
3. Press **ENTER** to return to the default screen, with the new brightness level.

➤ To set the screen brightness to 100%:

Press and hold the **MULTI** key for one second. The brightness is increased to 100%.

The brightness level is retained when you switch off the display.

Note: During night-time use, the brightness may be set very low, when subsequently operated during the day it may not be apparent that the display is on; press **MULTI**, followed by the second soft key from the left, then use the trackpad to increase brightness. Alternatively, press and hold **MULTI** for one second to set the brightness to 100%.

2.3 Controlling the Display

You control the display using the cursor and control keys. You start all operations from the default screen, that is the default soft keys are displayed:

Chart



Radar

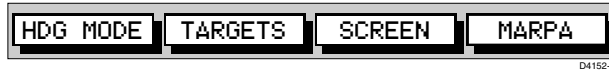

When you have completed an action using the soft keys, press **ENTER** or **CLEAR** to return to the default screen; you may need to press **ENTER** or **CLEAR** several times to back-track through the soft key hierarchy.

Note: *If you have set up your system so that the default soft keys are not displayed all the time, press any soft key to display the labels.*

The remainder of this section describes how to select the mode of operation and switch half-screen windows on/off. The following sections describe how to set up the display for the Radar and for the Chart.

The controls are summarized in the fold-out illustration on pages 2-11 and 2-12.

Selecting the Mode of Operation

You use the **DISPLAY** key to select the full-screen mode. If the data is available on your system, the following modes (described on *Operating Modes* on page 1-6) can be selected:

- Radar
- Chart and Radar/Chart Overlay
- Data log

The **DISPLAY** key also accesses the soft keys for the half-screen window options.

Note: *If your hsb² display system includes a Fishfinder display, refer to the Owner's Handbook supplied with your Fishfinder for operating details.*



- To change the mode, press the **DISPLAY** key to show the **DISPLAY** pop-up, then press again to cycle through the modes available, shown in the *Figure 2-5*.

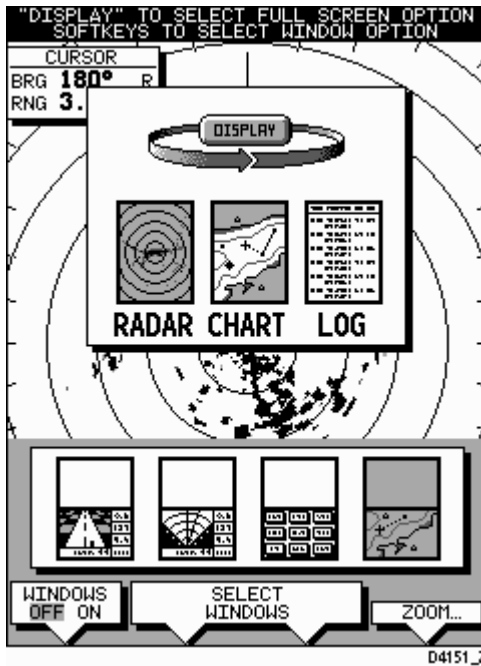

Figure 2-5: Using the **DISPLAY** Key

The selected mode is shown by an icon with a red border and the mode is displayed on the screen. The associated half-screen window soft keys are also displayed.

When the required mode is shown, press **ENTER** or **CLEAR**. The default soft keys are displayed. The selected mode is shown full-screen; in Radar and Chart mode you can switch on half-screen windows for additional display, as described in the following section.

If you press **DISPLAY** again, the pop-up and soft keys for the current mode are shown.

Selecting a Half-Screen Window for Display

Note: *Windows can only be used with Radar or Chart screens, they are not available on the data log screen.*

- To select a window for display:
 1. From the full-screen Radar or Chart mode, press the **DISPLAY** key. The following soft keys are displayed with an image of each available window:

Radar:**Chart:**

2. To select a different window, press either **SELECT WINDOWS** soft key until the required window is highlighted. If necessary, this will toggle windows on. Press **ENTER**.
3. To toggle windows off, press the **WINDOWS OFF ON** soft key.

Figure 2-6 shows the half-screen horizontal windows (in radar mode).

Switching Control Between Radar & Chart Screens

In a combined or an integrated system, to switch control between radar and chart, you can change the full-screen mode using the **DISPLAY** key. Alternatively, when you have both radar and chart displayed in half-screen windows the soft key **RDR CHRT** lets you toggle operating control between the radar and the chart window.

If a window is active, i.e. control of the cursor via the trackpad is available in that window, and you switch windows off, control automatically returns to the full-screen (upper window) mode.

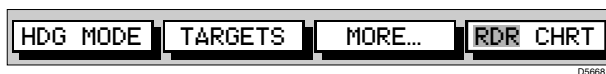
Radar:**Chart:**

- To change the active window, press the **RDR CHRT** soft key to toggle control between the radar and chart display. The current active display is highlighted in red on the **RDR CHRT** label and the cursor appears in that window.

Returning to the Full-Screen Display

To return to the full-screen display you can turn windows off, as previously described. Alternatively, to return to full-screen display:

- Press and hold the **DISPLAY** key for 2 seconds to return to the currently selected full-screen (upper window) display.

CDI Window

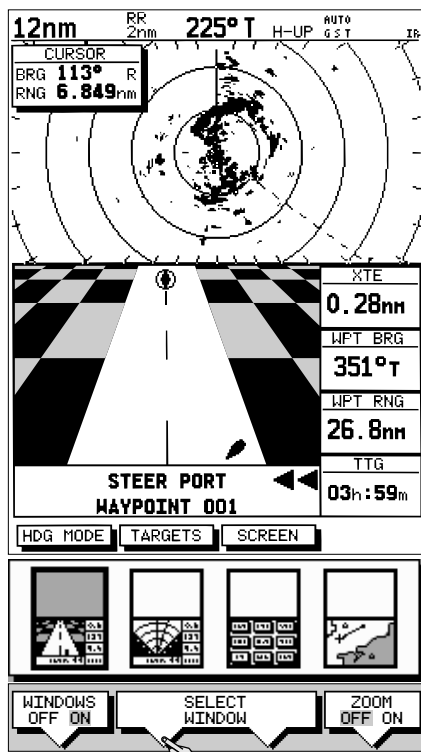

BDI Window

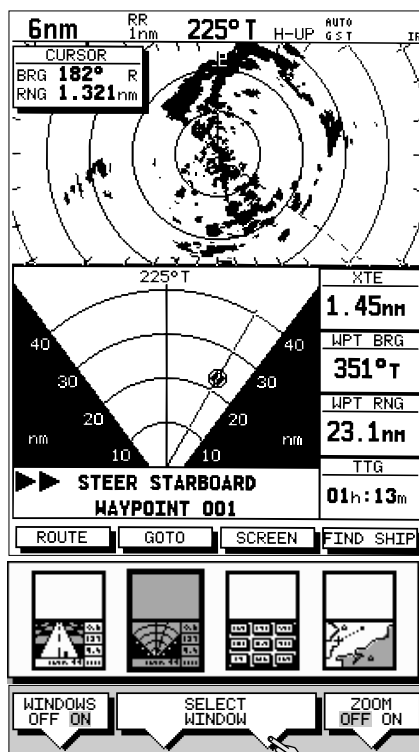

Navdata Window

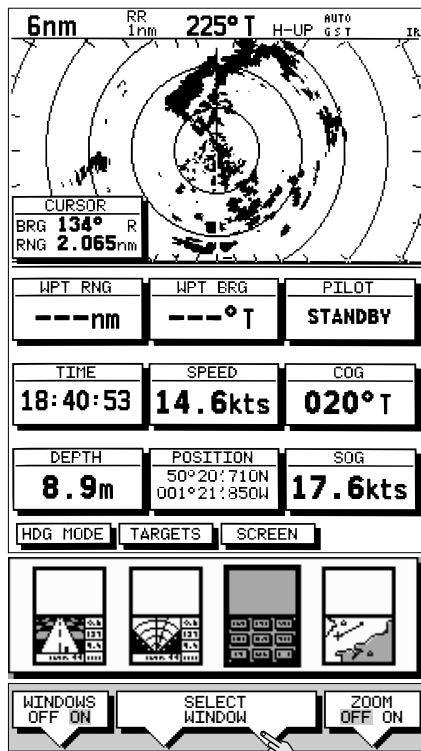

Chart Window

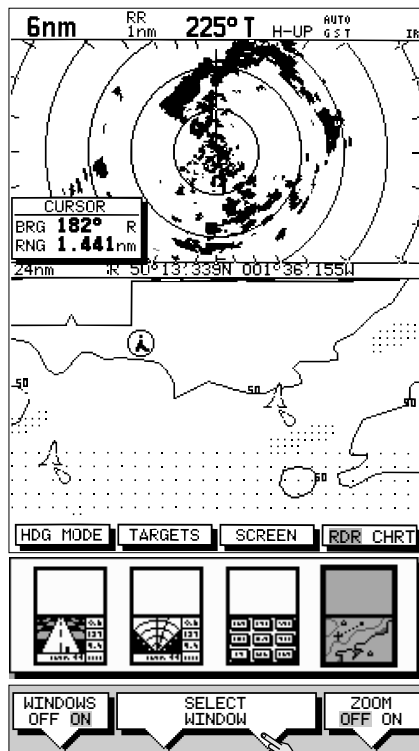
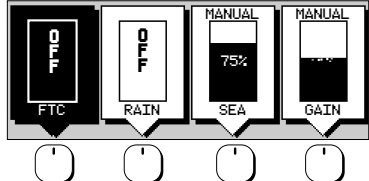

Figure 2-6: Radar Half-Screen Window Options

GAIN
Controls the presentation of radar targets.
GAIN controls background noise (speckle).
SEA controls sea clutter.
RAIN controls rain clutter around the vessel.
FTC controls rain clutter at a distance.
- Press for soft keys display.



Select a slider using the soft key or trackpad.
Toggle between Auto/Man or off/on by pressing soft key again.
Adjust slider using trackpad, and press **ENTER** to finish.

VRM/EBL
Used to measure range and bearing to/between targets.
- Press to place VRM/EBL if one not already placed.
Adjust position using trackpad, and press **ENTER** to finish.
- Press to display soft keys if VRM/EBL already placed.

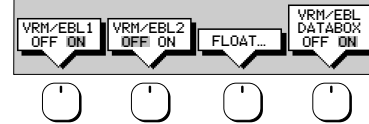

Use soft key to toggle VRM/EBL on or off.
Press FLOAT to access float options for existing VRM/EBL.
Press VRM/EBL DATABOX to toggle data box display off/on.

MULTI
Controls guard zone alarm sensitivity, and tuning the receiver.
Also controls display lighting and brightness.
- Press to display sliders.
Press and hold MULTI key to set brightness to 100%.

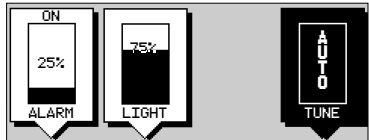

Select a slider using the soft key or trackpad.
Toggle between Auto/Man or off/on by pressing key again.
Adjust slider using trackpad, and press **ENTER** to finish.

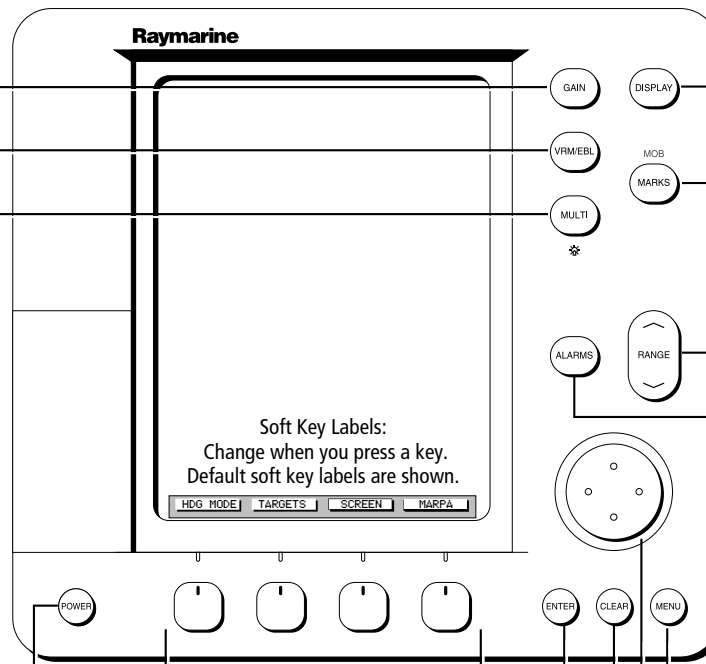

Soft keys
Press to select option, or highlight option or slider.
Labels change when you press soft/dedicated key.
Elipses (...) after the text indicate that pressing soft key leads to a further display of soft key options.

ENTER
Confirms selection and (if appropriate) clears current soft key labels. It performs the selected task, accepts changes, or leads to display of more options.
When cursor text is displayed, takes cursor control of the object.
When arrow-head cursor symbol is displayed, drops the object under cursor control.

CLEAR
Cancels operation in progress and returns to the previous display.
Deletes an object/function under cursor control.

Trackpad
Controls cursor position on the screen, and also the sliders and setup options.
Hold the trackpad down to move the cursor faster.

POWER
Press and hold until unit beeps to turn on display.
Press to toggle between Standby and Transmit.
Press for 3 seconds to turn off display.

DISPLAY
Controls display mode and windows.
- Press for display mode and soft keys display.
- Press again to toggle through display modes, and **ENTER**
- Press and hold for 2 seconds for full screen display of the upper window.

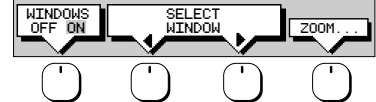

Press soft key to toggle window on/off, or return to full screen.
Zoom: Press ZOOM key to display zoom window option.
Move Zoom box using trackpad, press **ENTER** to finish.

MARKS / MOB
Controls placing marks, and Man Overboard function.
- Press to place mark at cursor position, and use trackpad to move mark. Press **ENTER** to finish.
- Press and hold for 2 seconds to activate or cancel MOB.

RANGE
Controls range scale. Range scale and range rings are shown in the Status Bar.
- Press top of key to increase the range scale.
- Press bottom of key to decrease the range scale.
- Press and hold to change the scale faster.

ALARMS
Used to control guard zones.
- Press to place guard zone if one not already placed.
Adjust size/shape using trackpad, press **ENTER** to finish.
- Press to display soft keys if guard zone already placed.

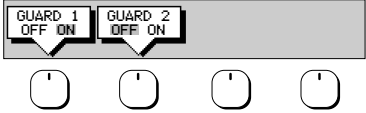

Use soft key to toggle zone on or off.
Adjust size/shape using trackpad, and press **ENTER** to finish.

MENU
Provides access to setup options.
- Press to display soft keys.

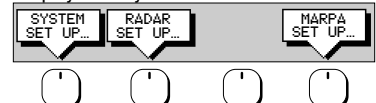

Press soft key to display required setup menu, then use trackpad to select option and soft key to change setting.
Press **ENTER** to close menu, and **CLEAR** to finish.

GAIN
Not used in Chart mode.

VRM/EBL
Use to measure range and bearing to/between points.
- Position cursor at start point, and press VRM/EBL key to display the Ruler data box. Select end point using trackpad, and press **ENTER** to fix end position of ruler.

MULTI
Controls display lighting.
Press and hold MULTI key to set brightness to 100%.
- Press to display slider.

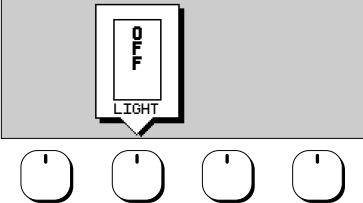

Select the slider using the soft key or trackpad. Toggle between off/on by pressing the soft key again. Adjust slider using trackpad, and press **ENTER** to finish.

ALARMS
Use to set up the chartplotter alarms.
- Press to display the Alarms set up menu and soft keys, the soft keys correspond to the selected alarm.

ALARMS SET UP	
ARRIVAL ALARM	0.01nm
OFF TRACK ALARM	OFF
ANCHOR ALARM	OFF
COUNTDOWN TIMER	00:33:00
ALARM CLOCK	OFF



Use the trackball to select the alarm, then use the softkeys to adjust parameters and/or toggle the alarm on/off. Press **ENTER** to finish.

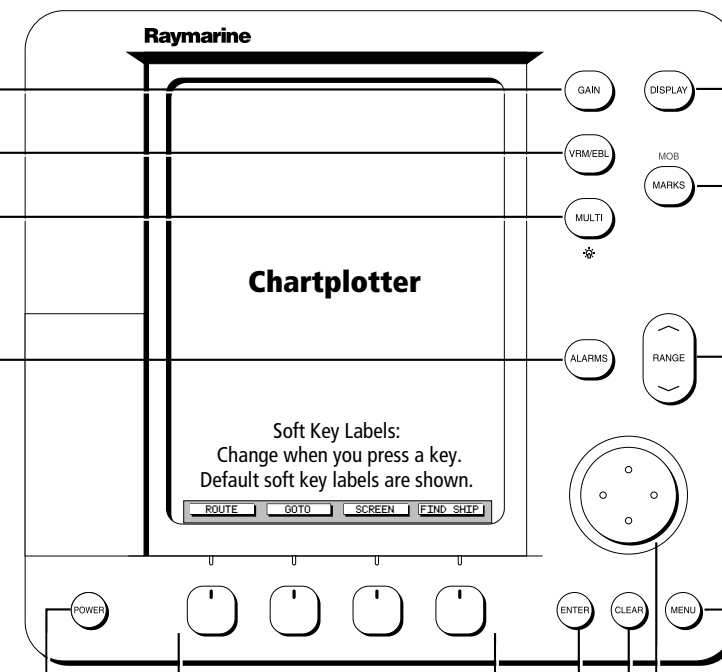

Soft keys
Press to select option, or slider. Labels change when you press soft/dedicated key. Elipses (...) after the text indicate that pressing soft key leads to a further display of soft key options.

ENTER
Confirms selection and (if appropriate) clears current soft key labels. It performs the selected task, accepts changes, or displays more options. When cursor text is displayed, takes cursor control of the object. When arrow-head cursor symbol is displayed, drops the object under cursor control.

CLEAR
Cancels operation in progress and returns to the previous display. Deletes an object/function under cursor control.

Trackpad
Controls cursor position and the slider values. Hold the trackpad down to move the cursor faster.

POWER
Press and hold until unit beeps to turn on display. Press for 3 seconds to turn off display.

DISPLAY
Controls display mode and windows.
- Press for display mode and soft keys display.
- Press again to toggle through display modes, then **ENTER**.
- Press and hold for 2 seconds for full screen display of the upper window.

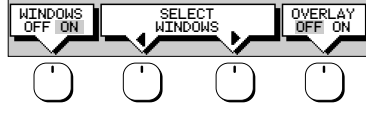

Press soft keys to toggle window on/off and to select lower window. Press **ENTER** to finish.

MARKS / MOB
Controls waypoints, and **Man Overboard** function.
- Press to display waypoint soft keys.
- Press and hold for 2 seconds to activate or cancel MOB.

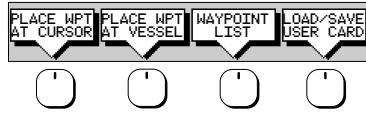

Press soft key to place waypoint at cursor or vessel, or display the waypoint list and associated soft keys. Press **ENTER** to finish.

RANGE
Controls chart scale. Displayed vertical distances are shown in the Status Bar.
- Press top of key to increase the chart distance.
- Press bottom of key to decrease the chart distance.
- Press and hold to change the scale faster.

MENU
Provides access to setup options.
- Press to display soft keys.

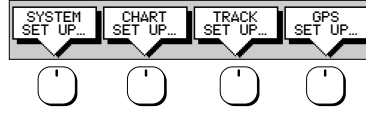

Press soft key to display required setup menu, then use trackpad to select option and soft key to change option. Press **ENTER** to close menu, and **CLEAR** to finish.

Customizing the Screen Presentation Options

The SCREEN soft key lets you set the following screen presentation options on or off:

Radar:



Chart:



Switching the Cursor Data Box On and Off

The cursor data box provides the cursor’s position in latitude/longitude and/or bearing/range. If you wish to see a full image, you can switch the data box off.

- To control the cursor data box:



1. Press the SCREEN soft key.
2. Press the CRSR BOX soft key to toggle the setting from OFF to ON or from ON to OFF.
3. To return to the default soft key display, press **ENTER**.

- You can move the cursor data box using the context-sensitive cursor.

Switching Radar Range Rings or Chart Grid On and Off

The radar range rings can be turned on or off. They are normally left on, but you may wish to turn them off if you are using VRM/EBLs or guard zones (see *Section 3.4* and *Section 3.5*) to make the display clearer.

The Chartplotter display includes grid lines of latitude and longitude which you can use to help determine position on the chart. The grid lines can be switched on if required.

If you are in Chart mode the RNGE RNGS soft key is replaced by the CHRT GRID soft key.

- To turn the range rings or chart grid on or off:



1. Press the SCREEN default soft key.
2. Press the RANGE RINGS or the CHRT GRID soft key to toggle the setting from OFF to ON or from ON to OFF.

To return to the default soft key display, press **ENTER**.

Data Boxes

A group of up to six data boxes can be displayed, if the information is available on your system. **You select which data is displayed in the boxes during system set up as described in *Chapter 7: Setting Up the System Defaults*.**

The default data box positions are along the bottom of the display. Each box can be moved to the required position on the screen using the context-sensitive cursor.

Note: *If you select BDI, CDI or Nav Data for display in a half-screen window, the data boxes are temporarily hidden.*

SCREEN

At any time, you can switch the *group* of data boxes on or off using the SCREEN soft key. When first installed, the boxes are all OFF. When the display unit is switched off and on again, the data boxes return to their last-used states (ON or OFF) and positions.

Note: *The SCREEN soft key does not control the sixteen data boxes that can be displayed in the half-screen window.*

- To switch the group of data boxes on or off:

SCREEN

DATABOXES
OFF ON

1. Press the SCREEN default soft key.
2. Press the DATABOXES soft key to toggle the setting from ON to OFF or from OFF to ON.

To return to the default soft key display, press **ENTER**.

If you turn the data boxes on and none are displayed, you need to select the ones you require using the system set up menu, as described in *Section 7.3, System Set Up Parameters*.

- To move any data box:

1. Use the trackpad to position the cursor over the box until the letters BOX are displayed.
2. Press **ENTER** to take control of the box, use the trackpad to move it to the required position, and press **ENTER** again.

Waypoint Display - Radar mode

If you are currently going to a waypoint, you can display the active waypoint on the radar picture. The waypoint may have been generated locally on the chartplotter, or received via the SeaTalk or NMEA interface.

Note: *If you use the GOTO CURSOR function, the active cursor is displayed as a lollipop symbol on the radar.*

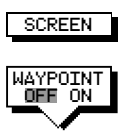

➤ To display the active waypoint:

1. Press the SCREEN soft key.
2. Press the WAYPOINT soft key to toggle the setting ON.

To return to the default soft key display, press **ENTER**.

The standard radar picture is displayed again, with the active waypoint joined to your vessel's position by a dotted line. If the waypoint is off-screen, the dotted line is extended to the edge of the radar picture.

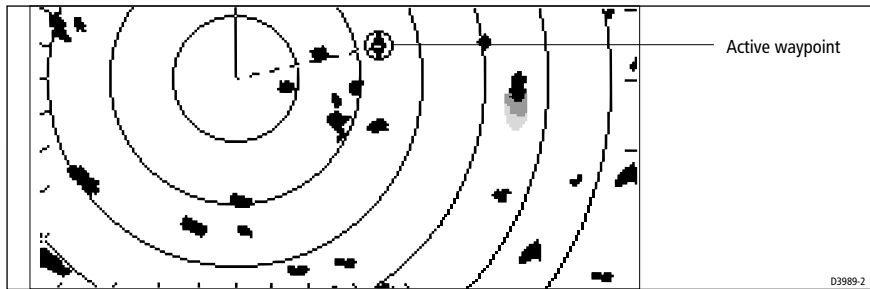

Figure 2-7: Active Waypoint on a Radar Display

Custom Options - Chart mode

When chart details have been customized in the Chart Set Up menu (as described in *Section 7.7*) the SCREEN soft key can be used to switch the custom chart options off or on:

When set to ON, all chart options set to CUSTOM in the Customize Chart menu are displayed; when set to OFF, options set to CUSTOM are not shown.

The factory default for custom chart options is ON.

➤ To switch the customized options on or off:

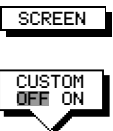

1. Press the SCREEN default soft key.
2. Press the CUSTOM soft key to toggle the setting from OFF to ON or from ON to OFF.

To return to the default soft key display, press **ENTER**.

2.4 Radar Display Control Functions

This section describes how to use the radar controls to:

- Use the zoom function to enlarge a selected area.
- Offset the center of the radar display.
- Momentarily hide the ship's heading marker (SHM).

Using the Zoom Function

If you wish to see a section of the radar picture in more detail, you can use the Zoom function to magnify the selected area to twice its size. There are two zoom options:

- **Zoom Into** - The enlarged area is displayed in a quarter-screen Zoom Window in the lower right corner of the screen. A box in the original radar picture indicates the enlarged area; you can move this using the context-sensitive cursor, thereby changing the image in the Zoom Window.

Note: *If the area you wish to enlarge is in the quarter of the screen that will be covered by the Zoom Window, you should offset the center (see the next section) to move the area to another part of the screen before selecting Zoom mode.*

- **Zoom From** - The enlarged area is displayed in the main window, with the original radar picture in a quarter-screen window in the lower right corner of the screen. A box in the original radar picture indicates the enlarged area; you can move this using the context-sensitive cursor, thereby changing the zoomed image.

Note: *You cannot use Zoom and Windows at the same time: if you turn one on, the other is turned off automatically, and restored when the latter is turned off again.*

► To enlarge an area:

1. Press the **DISPLAY** key. The soft keys are updated.



2. Press the ZOOM soft key to display the following soft keys

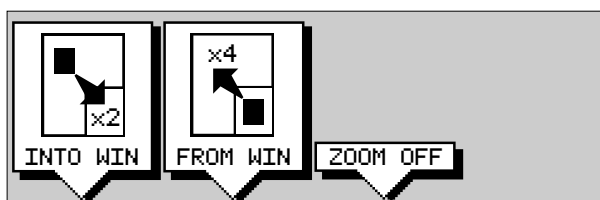

3. Press the required zoom option soft key, INTO WIN or FROM WIN.
The soft keys are cleared, and the cursor has control of the zoom box that indicates the area to be enlarged. This is indicated by the letters ZMB in inverse video, and the four-headed cursor symbol. The zoom box defaults to its last-used position since power-on.
 4. Use the trackpad to move the zoom box to the required area, and press **ENTER**.
The selected area is shown in an enlarged format, either in the quarter-screen Zoom window (INTO WIN) or in the main window (FROM WIN).
- To move the enlarged area in view in the window:
1. Move the cursor over the edge of the zoom box in the original radar picture, until the letters ZMB appear under the cursor.
 2. Press **ENTER** to take control of the zoom box. The cursor shape changes to a four-way arrow.
 3. Use the trackpad to move the zoom box over the required area.
 4. Press **ENTER** again to drop the zoom box, update the enlarged version, and return the cursor to normal control.

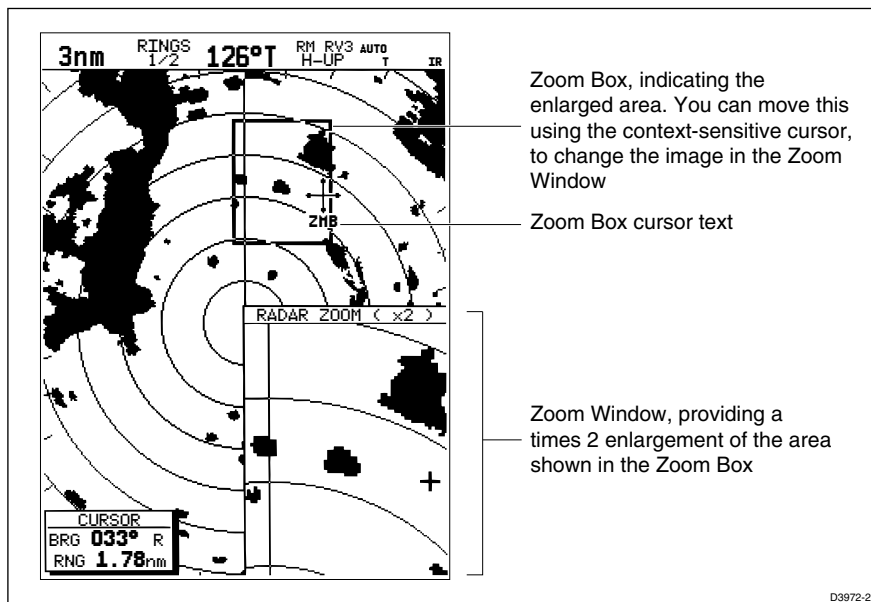

Figure 2-8: Radar Display Zoom Window

Press **DISPLAY** then **ENTER** to exit the Zoom mode.

Alternatively, you can press and hold **DISPLAY** for 2 seconds.

Offsetting the Center

The radar picture is normally shown with your vessel at the center of the display. However, you can move the center, so that your vessel is offset by up to 66% of the radius, anywhere on the screen.

Note: You cannot offset the center when the radar display is set to the longest range scale.

➤ To change the center:



1. Move the cursor over the center of the radar picture, until the letters CTR are displayed.
2. Press **ENTER** to take cursor control of the center point. The cursor changes to a four-headed arrow.
3. Move the cursor to the required off-center position.
4. Press **ENTER** again to set the position and return to normal cursor control.

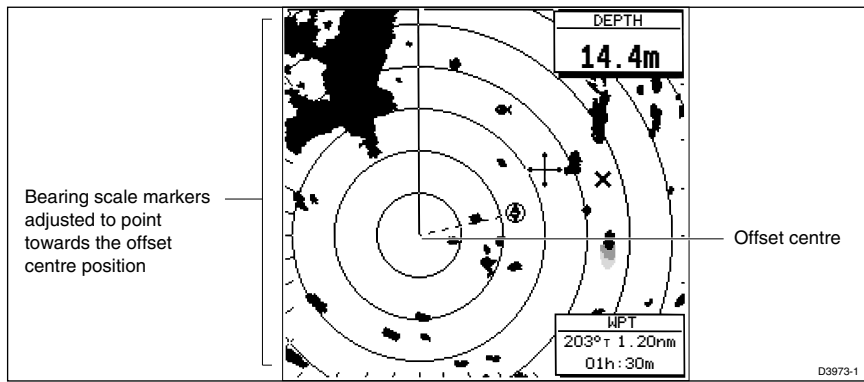

Figure 2-9: Radar Display with an Offset Center

- To return the center of the radar picture to the center of the screen, repeat step 1 and then press the **CLEAR** key. The center is always reset to the center of the display when you turn on the Radar display.

Note: When the center is offset, additional range rings are displayed to the edge of the radar picture, at the standard ring interval for the current range. If you have selected the longest range scale, you cannot offset the center.

Hiding the Ship's Heading Marker (SHM)

The radar picture includes the ship's heading marker, which is a line from your vessel's position to the edge of the picture at the vessel's current heading. In the standard Head Up mode, the heading marker is always a vertical line.

If you wish to check for small targets that may be hidden under the heading marker, you can hide it momentarily using the context-sensitive cursor.

➤ To hide the heading marker:

1. Position the cursor over the heading marker, so that the text SHM is displayed.
2. Press and hold **CLEAR**. The heading marker is hidden until you release the **CLEAR** key.

2.5 Chart Display Control Functions

Moving Around the Chart

You will normally operate the chartplotter with the chart showing your vessel's current location. The default orientation is North-Up, and the vessel moves across the screen. You will need to move the chart if your vessel moves out of the area currently displayed, or if you wish to examine or place waypoints in another area. Alternatively, you can *home* the cursor onto the vessel using FIND SHIP.

There are four ways in which you can move the chart:

- Use the trackpad to move the cursor to the edge of the chart. The chart will pan across. This method is useful if the area you wish to see is only just off the screen.
- Use the context-sensitive cursor to change the chart center.
- Automatically re-center the vessel using the FIND SHIP soft key.
- Change the chart scale to zoom out and in to a new area centered on the cursor position. This method is useful if the area you wish to see is a long distance away.

Changing the Chart Center

You can move the area of the chart displayed on the screen using the context-sensitive cursor. This allows you to center your vessel in the middle of the screen, or to move the chart so that your vessel is displayed off-center anywhere on the screen.

- To center the chart:



1. Use the trackpad to move the cursor to the vessel's position. The cursor text POS is displayed.
2. Press **CLEAR**. The chart is moved so that your vessel's position is in the center of the screen.

- To move your vessel's position off-center:



1. Move the cursor over your vessel's position until the letters POS are displayed.
2. Press **ENTER** to take control of the chart position. The letters POS are now in inverse video, and the cursor symbol has changed to a four-way arrow. This indicates that the cursor can be used to move the chart in any direction.

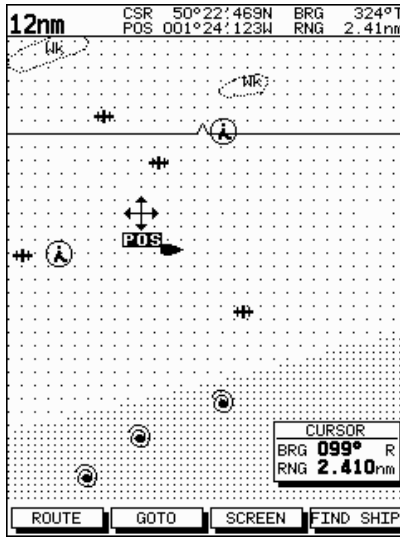

Figure 2-10: Changing the Chart Center

3. Use the trackpad to move the cursor to the required position.
4. Press **ENTER** to select the position and return to normal cursor control. The chart is redrawn with the vessel position at the cursor.
Alternatively, you can press **CLEAR** to abandon the move and leave the chart (and vessel) in its former position.

Using FIND SHIP

FIND SHIP is used in chart mode to re-draw the chart with the vessel at the center and the cursor homed onto the vessel.



When you press FIND SHIP the following occur:

- The chart is re-drawn with the vessel's position in the center.
 - The cursor is homed onto the vessel position and moves with it.
 - When the vessel moves near the edge of the chart window, the chart is redrawn to place the vessel and cursor at the center again.
 - The status bar indicates vessel position, speed and course over ground.
- To release the cursor from homed mode press the trackpad to move the cursor away from the vessel's current position. The status bar shows the cursor position, range and bearing.

Synchronize the Radar and Chart

If you have a combined radar/chartplotter display, with chart and radar windows on and you have selected Radar/Chart Synch in Chart Set Up (Section 7.7, Chart Set Up Parameters), FIND SHIP can be used to synchronize

the radar and chart images. It is recommended that you set the radar to True motion to ensure the radar and chart images remain synchronised when the vessel moves. When you press **FIND SHIP** the following occur:

- The chart is redrawn so that its center position matches that of the radar display.
- The radar is redrawn to the scale and heading mode of the chart.

Note: *Depending on the topology of the coastline, the radar returns may not relate to the charted shoreline, the radar image will therefore be different to the chart display. For example, a gently sloping beach with a cliff several hundred metres beyond the charted coastline, the cliff is not shown on the chart but will be displayed on the radar image.*

Changing the Chart Scale

The **RANGE** key allows you to change the chart scale so that you can see a smaller or larger area on the screen.

Plotter mode is available to allow you to zoom into a smaller area, even when no chart data is available for that scale. *Section 7.7* describes how to set plotter mode on/off.

You can change the chart scale for two purposes:

- To see either more detail (of a smaller area) or a larger area (in less detail) on the screen.
- To move the display to another area of the chart, by zooming out to a small scale chart, then zooming in on another position centered on the cursor.

The cartographic detail available on charts varies according to the chart scale and some areas include detail at smaller scales than others. This can cause blank areas on the display when adjacent areas with different levels of detail are displayed. To reduce this affect you can use the Chart Set Up options (see *Section 7.7*) to set chart display detail to simple. Then, as you zoom in, charted areas are displayed but with less detail shown.

Each time you press the **RANGE** key, the chart scale changes to the next available setting. The status bar indicates the distance from top to bottom of the screen, in nautical miles.

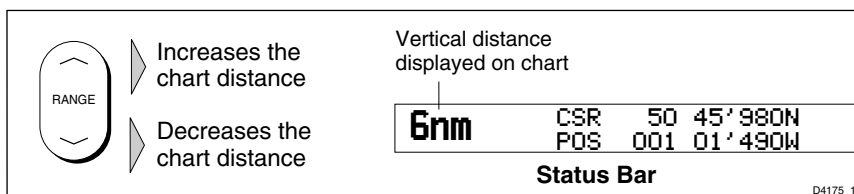

Figure 2-11: Changing the Chart Scale



- To change the scale quickly, press and hold the required arrow on the **RANGE** key.

The distance indicator at the left-hand end of the status bar is updated whenever you change the chart scale.



- To zoom in to a larger-scale (more detailed) chart:

1. Use the trackpad to position the cursor in the area you wish to see in more detail.
2. Press the lower part of the **RANGE** key to zoom into the area.

The section of the chart around the cursor is enlarged to fill the screen with a larger-scale chart showing more detail. The cursor is now positioned in the center of the screen.

The distance indicated at the top left of the screen is updated.

3. If further chart enlargement is available using the current chart card you can press the bottom of the **RANGE** key to zoom in again, re-positioning the cursor first if required.

An area of further chart detail is indicated by a box around the area as shown in *Figure 2-12*.

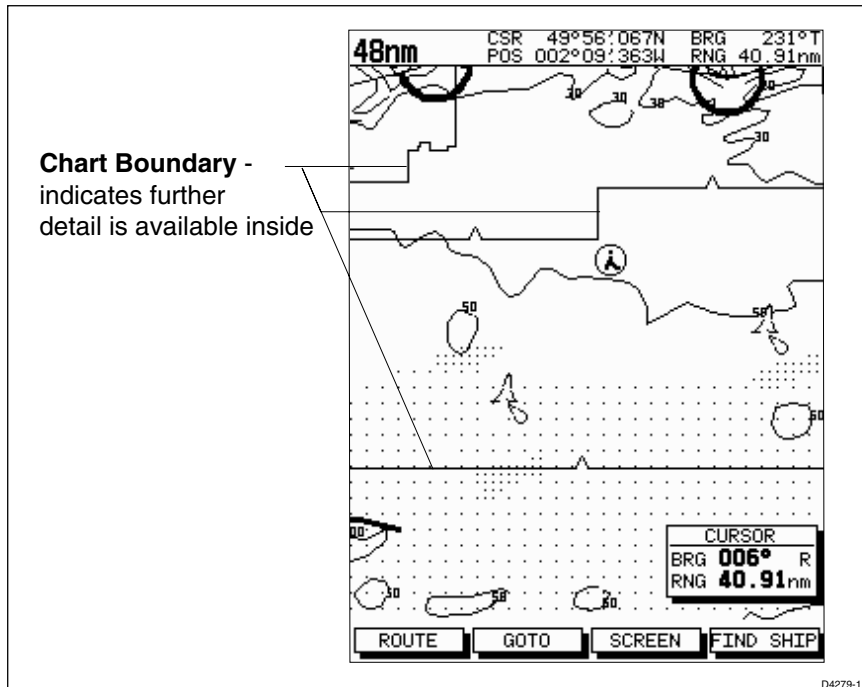

Figure 2-12: Chart Boundaries

4. When no further chart detail is available, as you press the bottom of the **RANGE** key, the effect depends on whether **Plotter Mode** is on or off as follows:

- If Plotter Mode is Off, the chart scale remains unchanged, indicating the smallest chart scale is displayed.

Note: *If Plotter Mode is Off and the cursor is homed to the vessel (see Using FIND SHIP on page 2-20), if the vessel moves outside an area of available cartography, the chart will automatically re-scale to the next range with cartography.*

- If Plotter Mode is On, the scale is decreased and the message NO CHART DATA is displayed. The vessel, waypoints, routes and tracklines are displayed without cartography.

The chart information is restored when you return to a chart scale for which the information is available.



- To zoom out to a smaller-scale (less detailed) chart, simply press the upper part of the **RANGE** key as many times as required.

Radar/Chart Overlay

If radar data is available, as a function of the combined radar/chart display or from another display connected on *hsb*², the radar targets can be overlaid on to the full-screen chartplotter display. The radar/chart overlay option helps you to distinguish between fixed, charted objects and other objects that could be moving vessels. Some radar controls are available in overlay mode.

The following criteria must be true for radar/chart overlay to function correctly:

- Position and heading data are provided so that vessel position and orientation can be determined. See *Heading and Position Data* on page 1-9 for further details.
- The vessel must be displayed on screen.
- The chartplotter must be in North Up or Course Up mode (see *Section 7.7*).
- The chartplotter range must be between 1/4nm and 48nm (equivalent to a radar range of 1/8nm to 24nm).
- Custom range scales are disabled on the radar.
- The radar must be transmitting.

To ensure the vessel remains on the screen, you could use Find Ship (see *Using FIND SHIP* on page 2-20) to home the cursor onto the vessel.

When Radar/Chart overlay is switched on, the status bar indicates OVL. If the option is switched on but the overlay is not visible (because one of the above criteria has failed), the status bar indication changes to (OVL).

When Radar/Chart overlay is switched on the soft key MORE... provides access to the SCREEN soft key and to the radar controls TARGETS and MARPA. The radar **GAIN** control is also active in overlay mode.

Note: *Radar/Chart overlay is displayed at the current chart range. You should be aware that if radar is shown on any other display, its range will match that displayed on Radar/Chart overlay. Conversely, if you change the radar range on any display, the Radar/Chart overlay image will change to the new radar range.*

➤ To select radar/chart overlay:



1. Press the **DISPLAY** key to show the DISPLAY pop-up, then if necessary press again to select Chart mode.
2. Press the OVERLAY OFF ON soft key to toggle the option on.

The two highest intensity radar returns are displayed in purple, over the chart image. The radar image is translucent, so that chart text, contours and outlines are visible beneath the radar targets.

2.6 Typical Chart Scenarios

The following illustrations provide operating guidelines for typical navigation scenarios. These scenarios can be used as a training guide; they show you how to perform a particular operation and they introduce many of the chartplotter functions.

Each scenario indicates the key presses required to perform particular tasks. A typical chartplotter screen image is shown for each task.

The scenarios assume you have read the previous sections of this chapter and that you are familiar with the Operating Controls. Full operating details for each function are provided in *Chapter 5* and *Chapter 6*.

Operating guidelines are provided for the following scenarios:

- **Working with Waypoints**
 - Place a Waypoint
 - Goto a Waypoint
- **Make and Follow a Routes**
 - Create a Route
 - Follow a Route
- **Review the Passage Plan**
 - View Route Information
 - Change the SOG, Hours and ETA.
- **Displaying the Radar Image and Synchronizing Radar & Chart**
 - Changing the Full-Screen Mode & Selecting Half-Screen Windows
 - Radar and Chart Synchronization (Find Ship)
 - Cursor Echo

Place and Goto a Waypoint

Place and Goto a Waypoint

1

1. Press MARKS

2

2. Position Cursor as required

Press the soft key

3

Press the soft key to go to the waypoint selected by the cursor.

SOFTKEYS TO SELECT

WAYPOINT 001
BRG 191°T
RNG 2.2nm

GOTO WAYPOINT	EDIT WAYPOINT	ERASE WAYPOINT	MOVE WAYPOINT
---------------	---------------	----------------	---------------

4

The vessel navigates towards the target waypoint

See:
5.3 Working with Waypoints
Go to an individual Target Point,
page 5-26.

D4267-2a

Place and Goto a
Waypoint

Make and Follow a Route

1

ROUTE GOTO SCREEN FIND SHIP

ENTER CLEAR MENU

Press the soft key

2

MAKE ROUTE EDIT ROUTE CLEAR ROUTE MORE...

ENTER CLEAR MENU

Press the soft key

3

12nm CSR 41°58' 74N BRG 191°
POS 070°09' 46W RNG 1.35nm

Provencetown

Race Pt

WPT

The Panet

The Path

The dutt

Inside Hole

Mast Range

Helifie

Middle

PLACE WAYPOINT UNDO WAYPOINT ACCEPT ROUTE

GAIN DISPLAY

VIEWER MOB MARKS

MULTI *

ALARMS RANGE

ENTER CLEAR MENU

1. Position Cursor - in this example over an existing waypoint

2. Press the soft key

4

12nm CSR 41°55' 78N BRG 219°
POS 070°14' 73W RNG 6.76nm

Provencetown

Race Pt

WPT

The Panet

The Path

The dutt

Inside Hole

Mast Range

Helifie

Middle

01

02

PLACE WAYPOINT UNDO WAYPOINT ACCEPT ROUTE

GAIN DISPLAY

VIEWER MOB MARKS

MULTI *

ALARMS RANGE

ENTER CLEAR MENU

Position Cursor for next waypoint, then press soft key.
Repeat to plot all waypoints in sequence.

D4268-1

5

Press the soft key. The route becomes the current route.

6

Press the soft key

7

Press the soft key

8

The vessel starts to navigate to the first (target) waypoint in the route.

See:
5.4 Working with routes, Follow a route, page 5-24.
Other Follow Options, page 5-25.

D4268-2a

Review Your Passage Plan

1 Press the soft key

2 Press the soft key

3 Press the soft key

4

1. Use the trackpad to move selection bar over required route.
2. Press the soft key

5

Time defaults to ETA - and assumes the current time is the start time.

CSR 50°35'31N BRG 127°1
 POS 002°24'54W RNG 1.91nm

3nm

INFO FOR ROUTE-LULWORTH COVE

WPT	POSITION	BRG	DISTANCE	TOTAL	TIME
	°T	nm	nm	nm	HOURS
01	50°36'69N	246	0.5	0.5	00:00
	002°26'16W				
02	50°36'38N	092	6.9	7.4	00:29
	002°15'16W				
03	50°36'90N	020	0.5	8.0	00:32
	002°14'85W				

TIME	ACTUAL	PLANNED	SOG
ETA HOURS	15.0kn	8.0kn	

6

GAIN DISPLAY

VIEWER MOB

MULTI MARKS

*

ALARMS RANGE

ENTER CLEAR MENU

See:
Displaying Route Information
page 5-18.

Change the TIME to HOURS - the display indicates it will take 32 minutes to reach the destination. You can change the PLANNED SOG; the display updates to indicate TIME required at the planned speed.

D4269-2a

Displaying the Radar and Synchronizing Radar & Chart

Displaying the Radar and Synchronizing Radar & Chart

1

1. Press **DISPLAY** - then press twice more to select RADAR.

2. Press the soft keys to set windows ON. The Chart window is the default selection.

3. Press **ENTER**.

2

Press the soft key. You can control the chart cursor.

3

1. Press **MENU**.

2. Press the soft key

D4293-1

4

TRACKPAD TO MOVE SELECTION POINT.
SOFTKEYS TO SELECT CHART ORIENTATION

CHART SETUP MENU

- PLOTTER MODE ON
- CHART ORIENTATION NORTH UP
- OBJECT INFORMATION ON
- WAYPOINT ON
- WAYPOINT NUMBERS ON
- DEFAULT WAYPOINT SYMBOL X
- HEADING VECTOR OFF
- COG VECTOR OFF
- TIDE VECTOR OFF
- RADAR/CHART SYNCH. OFF**
- DATUM SELECTION WGS 84
- DATUM OFFSET ON

CURSOR
BRG 034° R
RNG 2927nm

OFF ON

GAIN DEPLAY
VIRMEBL MOB MARKS
MULTI *
ALARMS RANGE
ENTER CLEAR MENU

1. Move selection bar over Radar/Chart Synch.

2. Press the soft key.
3. Press **ENTER** twice.

5

ROUTE GOTO MORE RDR CHRT

ENTER CLEAR MENU

Press the soft key.

6

SCREEN FIND SHIP MORE RDR CHRT

ENTER CLEAR MENU

Press the soft key to synchronise the chart & radar images.

7

1/2 nm RR 334° T ANTO H-UP 6.5 T

1/2 nm CSR 50°47'45"N 001°06'39.5"E

SCREEN FIND SHIP MORE RDR CHRT

GAIN DEPLAY
VIRMEBL MOB MARKS
MULTI *
ALARMS RANGE
ENTER CLEAR MENU

The radar and chart windows are synchronised and the cursor is 'homed' on the vessel

Move the chart cursor - you can see chart cursor move on the radar screen.

You can move the cursor over a radar target to determine its identity on the chart

See:

- 2.3 Controlling the Display
- 6.5 Cursor Echo
- 7.3 System Parameters
- 7.6 Chart Set Up

D4293-1a

Chapter 3: Standard Radar Operations

3.1 Introduction

This chapter provides detailed instructions for the standard radar operations of your *hsb²* series Pathfinder Radar. Additional functions, that are available on integrated systems with appropriate data sources, are described in *Chapter 4*. If you have a combined radar/chart display refer to *Chapter 5* and *Chapter 6* for information on charting operations.

You can use this chapter with the radar display set to simulator mode, or on the water after you have installed and set up your *hsb²* series Pathfinder Plus Radar system.

This chapter covers the following topics:

- Range control.
- Interpreting and adjusting the radar picture, including adjusting the gain, sea clutter and rain clutter, changing the targets display, and tuning the radar.
- Measuring range (distances) and bearings using Variable Range Markers (VRMs) and Electronic Bearing Lines (EBLs).
- Setting up guard zones and handling alarms.
- Using MARPA for target tracking and risk analysis.

Note: *Until you are familiar with interpreting the radar display, you should take every opportunity to compare the radar's display patterns with visual targets, such as other vessels, buoys and coastal structures. You should practice harbour and coastal navigation during daylight and in clear weather conditions.*

If you have a combined radar/chartplotter, or have an *hsb²* series Chartplotter as part of an integrated system, you can identify objects using either the radar/chart overlay (see *Radar/Chart Overlay* on page 2-23) or the cursor echo feature: With cursor echo on (see *Section 4.5* and *Chapter 7*) you can select an object on the radar display, the cursor is repeated on the chart display so you can check the object's identity.

3.2 Range Control

The radar picture can be viewed at various scales. The shortest range scale gives a maximum range of $\frac{1}{8}$ nautical miles, measured from the default centre to the top of the radar picture. The longest range scale gives a maximum range of between 24 and 72 nautical miles depending on your scanner.

- The *long* range scales provide the best overview of your vessel's relationship to land masses, weather fronts and large ship targets in or beyond view.
- The *short* range scales provide greater detail of the radar echoes close to your vessel, and should be used as you approach the coastline, harbour or other vessels in the area.

The Pathfinder Plus Radar display includes concentric range rings, which you can use to help you to judge distances on the radar picture. Their number and spacing are adjusted automatically if you change the range scale. They can be turned off (see *Switching Radar Range Rings or Chart Grid On and Off on page 2-13*).

Changing the Range

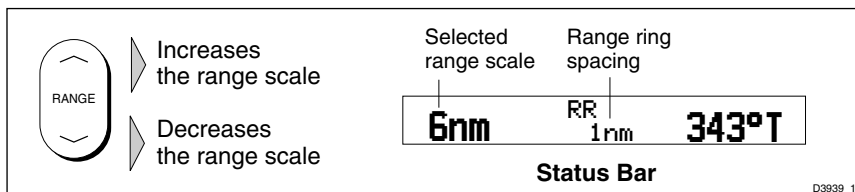

Figure 3-1: Changing the Radar Range



- Each time you press the **RANGE** key, the range changes to the next available setting. The system will beep three times if no further range scale is available.
- To change the range quickly, press and hold the required arrow on the **RANGE** key.

The range scale and range ring interval indicators, at the left-hand end of the status bar, are updated whenever you change the range.

The Standard Range Scale

Details of the standard ranges that can be selected are shown in the table below. If you wish, you can customize the range scales by specifying different ranges, as described in *Section 7.4, Radar Set Up Parameters*.

Table 3-1: Radar Range Scales

Maximum Range (nm)	Number of Range Rings	Range Ring Interval (nm)
0.125	2	0.0625
0.25	2	0.125
0.5	4	0.125
0.75	3	0.25
1.5	6	0.25
3	6	0.5
6	6	1
12	6	2
24*	6	4
48*	6	8
72*	6	12

* The maximum range depends on your scanner type, as detailed in the *Pathfinder Plus Radar Scanner Owner's Handbook*.

The number of range rings shown in the table is the number to the selected range. Additional range rings are displayed to the edge of the radar picture, at the standard ring interval for the current range, and are visible when the centre is offset.

Determining Actual Radar Range

The actual maximum radar range is essentially line-of-sight, and is limited by the height of the scanner and the height of the target as shown in *Figure 3-1*.

Table 3-2 lists some range examples:

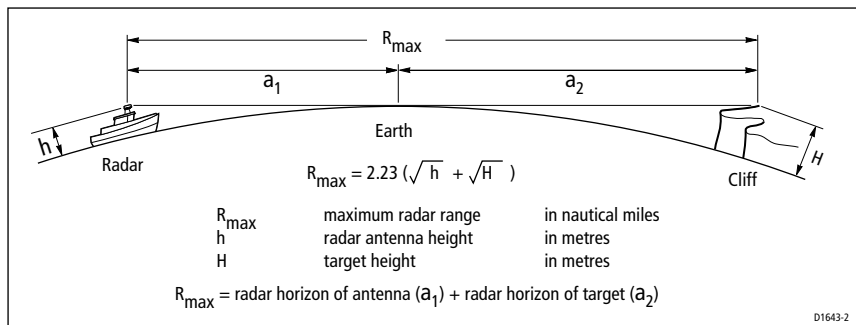

Figure 3-2: Determining Radar Range

Table 3-2: Radar Range

Antenna Height (m)	Target Height (m)	Maximum Range (nm)
3	3	7.8
3	10	10.9
5	3	8.9
5	10	12.0

Note: *The ranges shown in the table are theoretical maximum ranges. The radar horizon is greater than the optical horizon, but the radar can only detect targets if a large enough target is above the radar horizon.*

3.3 Interpreting and Adjusting the Radar Picture

Navigational echoes may be large, small, bright or faint, depending not only on the size of the object but also on its orientation and surface. Different objects reflect the radar signals in different ways. For example, vertical objects such as cliffs reflect signals better than sloping ones such as sandbanks.

High coastlines and mountainous coastal regions can be observed at the longest radar range. However, the first sight of land may be a mountain several miles inland from the coastline. The actual coastline may not appear on the radar until the vessel is close to the line of sight distance.

The radar indication may not be similar to your visual observation; a nearby small object may appear to be the same size as a distant large object on the radar. However, with experience the approximate size of different objects can be determined by the relative size and brightness of the echoes.

Some targets, such as buoys and small boats, can be difficult to differentiate, since they bob and toss about in the waves and do not present a consistent reflecting surface. Consequently, these echoes have a tendency to fade and brighten and, at times, to disappear momentarily. Buoys and small boats often resemble each other, but boats can usually be distinguished by their motion.

Not all radar echoes are produced by hard navigational items. Some echoes may be received from irregularities on the surface of the water, particularly at close range (sea clutter), or from rain or snow either around the vessel or in the distance. In addition, some echoes may be indirect returns to the radar scanner, providing false echoes or multiple echoes.

The effects of many false echoes can be minimized, and the target presentation clarified using the controls summarized below. This section explains how to interpret the radar picture and how the controls affect the display. It provides instructions for adjusting the settings, describes the circumstances in which they should be adjusted, and how they interact with each other.

Table 3-3: Controls to Adjust the Radar Picture

Control	Option	Function	Default Setting
GAIN	GAIN	Controls the strength of the target returns	AUTO
	SEA	Reduces sea returns	AUTO-HARBOUR
	RAIN	Reduces close rain or snow returns	OFF
	FTC	Reduces distant rain or snow returns	OFF
MULTI	TUNE	Fine tunes the receive	AUTO
TARGETS Soft Key	INT REJ	Turns interference rejection on/off	ON
	EXPANSION	Turns target expansion on/off	OFF
	WAKES	Turns wakes on/off and selects wakes length	OFF

Identifying False Echo Returns

Not all echoes are direct returns to the radar antenna. Occasionally signals appear at positions where there is no actual target. These are called *false echoes*, and may be caused by side lobes, ghost images, indirect echoes or multiple echoes.

This section briefly describes the echo patterns that can be produced by false echoes and the likely cause. It should be noted that the radar operator, through observation, practice, and experience, can generally detect these conditions very quickly. These effects can usually be minimized using the radar controls.

Side Lobes

A small part of the RF energy from each transmitted pulse is radiated outside the single narrow beam. This produces side lobe patterns, shown in *Figure 3-3*.

Side lobes have no effect on distant or small surface objects. However, the echo from a large object at short range may produce an arc on the radar screen similar to a range ring or a series of echoes forming a broken arc. Side-lobe echoes normally occur at ranges below 3nm, and can be reduced by adjusting the SEA control.

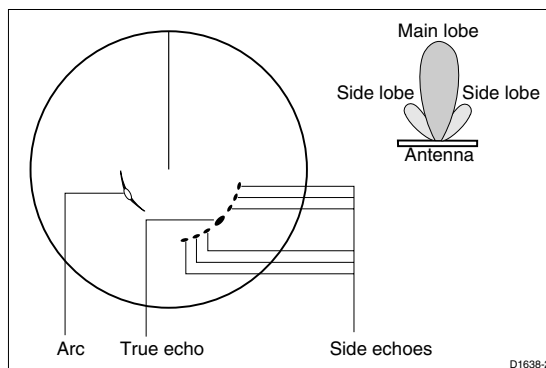

Figure 3-3: Side Lobes

Indirect Echoes

There are several types of indirect echoes or ghost images - some examples are shown in *Figure 3-4*. These sometimes have the appearance of true echoes, but in general they are intermittent and poorly defined.

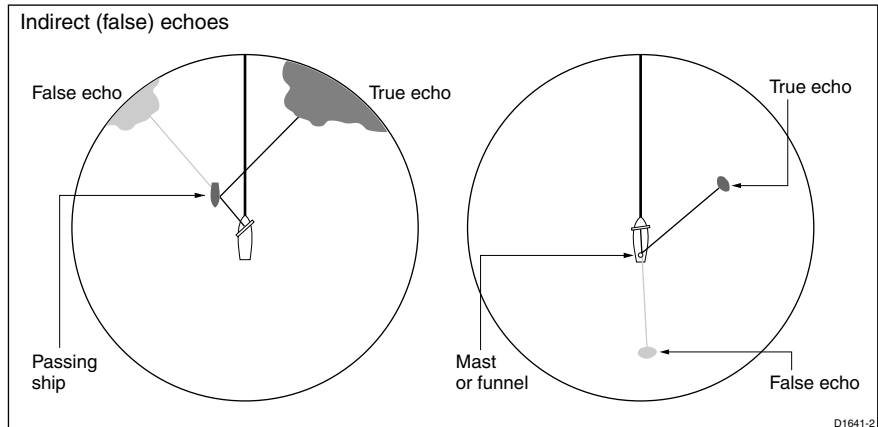

Figure 3-4: Indirect Echoes

Multiple Echoes

Multiple echoes appear if there is a large target with a wide vertical surface at a comparatively short range. The transmitted signal will be reflected back and forth between the target and your own ship. Multiple echoes therefore appear beyond the true target's echo on the same bearing, as shown in *Figure 3-5*.

This is not very common.

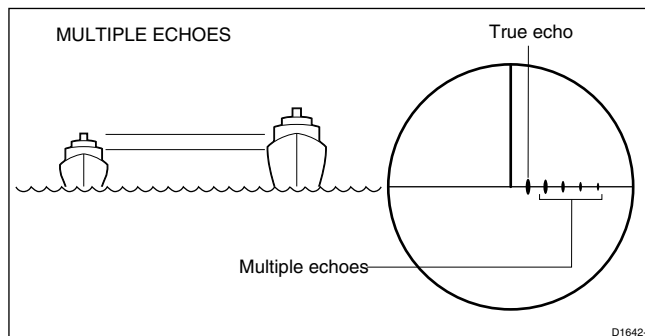

Figure 3-5: Multiple Echoes

Blind Sectors or Shadow Effect

Funnels and masts located near the antenna, may cause shadows. In shadow areas beyond the obstruction there will be a reduction of the beam intensity, although not necessarily a complete cut-off. However, there will be a blind sector if the subtended angle is more than a few degrees. There may also be multiple echoes which extend behind the obstruction. This should be avoided by careful selection of the scanner site prior to installation (*Chapter 8*).

Adjusting Gain, Sea Clutter, Rain Clutter and Tune

Automatic adjustment of Gain, Sea and Tune is available, alternatively you can set any of these parameters to manual and use the trackpad to adjust its value. Rain clutter is adjusted manually using the RAIN or FTC control. **GAIN**, **SEA**, **RAIN** and **FTC** are accessed from the **GAIN** key; **TUNE** is accessed from the **MULTI** key.

Note: *Gain, Sea and Tune can only be adjusted if the control is set to Manual adjustment.*

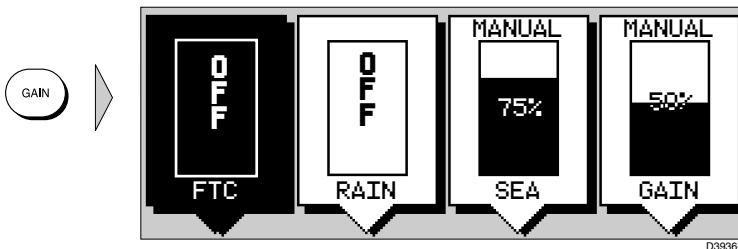

When you select manual **GAIN**, **SEA** or **TUNE** adjustment the soft key icon shows a vertical slider bar. As you press the trackpad, the value is indicated in the slider.

When you switch **FTC** or **RAIN** On, the soft key icon shows a vertical slider bar. As you press the trackpad, the value is indicated in the slider.

If you change the settings, the new **GAIN**, **SEA** and **TUNE** modes (auto or manual) and values remain set even when you turn the radar off and on again; Rain and **FTC** are reset to Off at power-on. The status bar indicates which controls are switched to Auto or On, as shown in *Figure 3-6*.

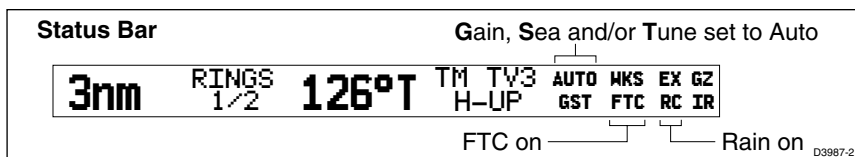

Figure 3-6: Radar Status Bar

➤ To adjust a parameter:

1. Select a range appropriate to the adjustment you wish to make. The optimum Tune setting varies slightly for different ranges, depending on the pulse width used.
2. Press **GAIN** or **MULTI**. The slider soft keys are displayed. The last-used slider is highlighted (displayed in inverse video) to show that it is selected.
3. Press the required soft key so that the slider box is highlighted. The **TUNE** and **GAIN** soft keys toggle the control between Auto and Manual mode. The **SEA** soft key toggles the control between Auto-Harbour, Auto-Offshore and Manual mode. If you select Manual mode the last auto setting is retained. You can only move the slider if the control is set to Manual.



- Use the trackpad to move the slider up or down. You can press and hold the control to move the slider quickly rather than in single steps.

The image on the screen changes as you move the slider, so that you can see the effect of your adjustment.

If you select MANUAL TUNE adjustment, an 8-step signal-strength indicator bar is displayed above the slider. Adjust the slider to obtain the maximum reading on the indicator.

Note: *Because the changes to the settings are made immediately, you cannot revert to the previous setting by pressing **CLEAR**.*

- When you have set all the controls to the levels you require, press **ENTER**, or **CLEAR** to clear the slider display. The status bar is updated to indicate which controls are switched to Auto or On.

Gain Control and Sea Control

The GAIN control can be set to either Auto or Manual. In Auto mode, the Pathfinder Plus radar optimizes the setting. The SEA control can be set to Auto-Harbour (default), Auto-Offshore or Manual mode. In Auto-Offshore mode, the Pathfinder Plus Radar optimizes its settings to account for the effects of sea clutter. **In harbours or close proximity to land different auto settings may be necessary to cater for the effects of land clutter. To avoid losing small targets it is therefore advisable to set the Sea control to Auto-Harbour mode. Alternatively, set both Sea and Gain to Manual mode then adjust the settings to ensure that all close small targets are visible.**

The GAIN control adjusts the level of the display of signals received from the scanner; it is equivalent to a volume control on a radio.

Because the SEA control affects the gain, you may need to manually readjust it if you manually change the Gain setting.

Gain Control

When the GAIN control is set to Manual, you should check it every time you change the range scale.

On long range settings, the gain should be set to give a slight speckle in the background of the radar picture. Do not set the gain too low, or you may miss small or weak targets.

On shorter ranges, you may wish to reduce the gain slightly to reduce the speckle and therefore improve target definition.

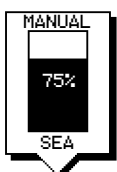
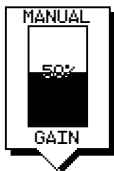

Sea Clutter Control

Radar returns from waves around your vessel can clutter the centre of the radar picture (see *Figure 3-7*, making it difficult to detect real targets. Such *sea clutter* usually appears as multiple echoes on the display at short range scales,

and the echoes are not repetitive or consistent in position. With high winds and extreme conditions, echoes from sea clutter may cause dense background clutter in the shape of an almost solid disc.

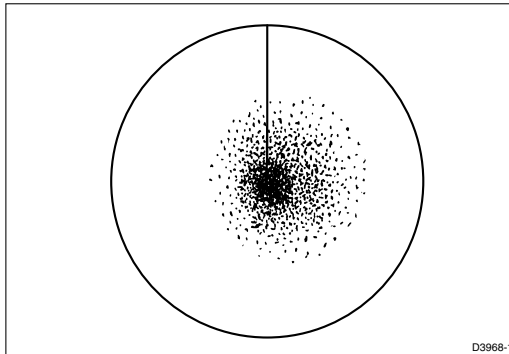

Figure 3-7: Sea Clutter

The SEA control reduces the gain level in the areas near your vessel, extending up to 3 to 5nm depending on the wave and sea conditions. This has the effect of reducing the sea returns to intermittent small dots, while small targets are still visible. Gain levels further from your vessel remain unchanged.

You can use the gain and Sea control to help minimize the effects of side lobes (see *Identifying False Echo Returns* on page 3-5).

Note: *On short range scales, do not set the Sea control so high that all clutter is removed, since this could stop you seeing echoes from close targets.*

Tuning the Receiver



The TUNE control is used to fine tune the receiver in the scanner for maximum target returns on the display. In Auto mode, the radar tunes itself automatically on all range scales. **We recommend that you leave the TUNE control in Auto mode.**

If you do set the TUNE control to Manual, you will need to adjust it about 10 minutes after you have turned on the radar, since the required setting changes once the magnetron has warmed up.

You should adjust the control to obtain the maximum signal strength, as indicated in the 8-step bar above the slider. If you cannot tune the radar successfully, refer to *Section 7.6* for information on the Tune Preset function.

Rain Clutter Control, using RAIN and FTC

The radar can see echoes from rain or snow. Returns from storm areas and rain squalls consist of countless small echoes that continuously change size, intensity, and position. These returns, shown in *Figure 3-8* sometimes appear

as large hazy areas, depending on the intensity of the rainfall or snow in the storm cell.

The RAIN and FTC controls are used to reduce this clutter, so that targets masked by the clutter can be seen on the radar picture.

- The RAIN control is used to reduce large clutter masses around your vessel caused by rain or snow.
- The FTC (Fast Time Constant) control is used to reduce rain clutter at a distance from your vessel, such as that shown below.

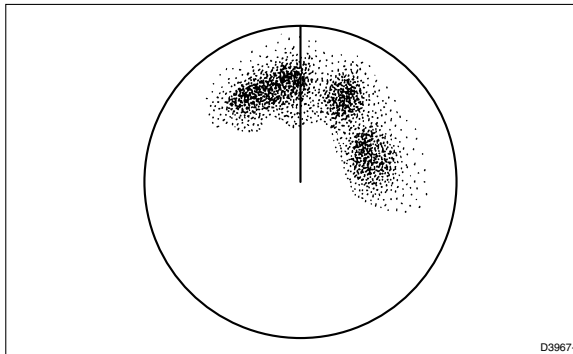
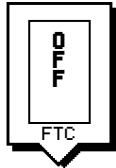

Figure 3-8: Rain Clutter



When the FTC control is turned up, only the leading edge of large (rain clutter) echoes is displayed, while the effect on smaller (ship) echoes is only slight. This means that you can also use the control on shorter ranges to distinguish between two very close echoes on the same bearing, which may otherwise merge and appear as one echo.

When the FTC control is turned up, the receiver is less sensitive, and there is a reduction of background noise and fill-in returns from land and large targets. You should therefore turn the control down when its use is not required. Since storm cells are usually visible for long distances due to their extreme altitude, you may wish to leave them displayed so that you can observe the location of bad weather.

If you turn the RAIN or FTC control Off (equivalent to setting the level to 0%), the actual setting is stored, and restored when you turn the control on again.

Note: RAIN and FTC are reset to Off at power-on.

Changing the Targets Display

The Pathfinder Plus Radar allows you to improve target visibility by changing the following:

- Interference rejection
- Target expansion
- Target wakes

These parameters are accessed from the default soft key TARGETS.

This section explains how to change these modes and describes the effect of each mode. The current settings are shown at the right-hand end of the status bar as shown in *Figure 3-9*.

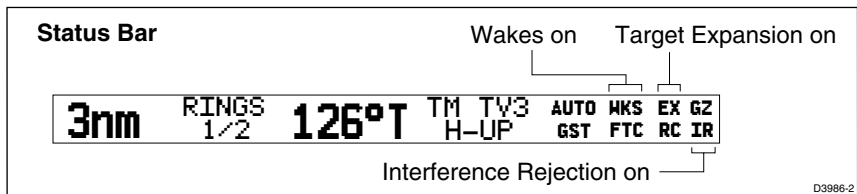

Figure 3-9: Status Bar

► To change the settings of the target modes:

1. Press the TARGETS default soft key.
The target option soft keys are displayed, with the current selections highlighted.



2. Press the appropriate soft key to toggle the required setting between OFF and ON.

Note: If an option is not available for the current setting, its soft key label is grey. When you press the key, the system beeps and the setting remains OFF.



For the Wakes mode, press the WAKES soft key to step the highlighted selection through the wake options.

You can use the soft keys to change the settings of any or all the modes on this display.

3. When the required options are highlighted, press **ENTER**. The screen returns to the default display with the new mode(s) in operation. The status bar is updated to indicate which controls are switched on.

Interference Rejection



Mutual radar interference is likely when two or more radar-equipped vessels are operating within range of each other. This usually appears as a series of small dots moving to and from the display center in a straight line or a long, sweeping curve. This type of interference is most noticeable at long ranges.

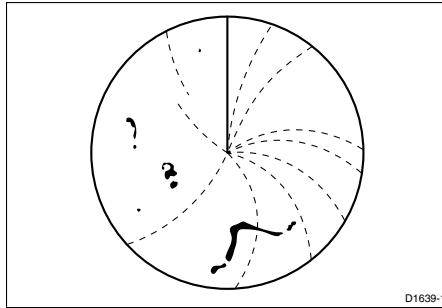

Figure 3-10: Interference Rejection

The Pathfinder Plus Radar includes a mechanism that automatically reduces such interference. This mechanism is normally left switched on. However, if you wish to detect the presence of other radars in the vicinity, you can turn off the interference rejection.

Target Expansion



You can make targets easier to see by expanding them. The scanner type determines the range at which target expansion is available. Target expansion overrides the normal pulse length, thereby increasing the size of the target seen on the screen. However, this is at the expense of range resolution.

Target Wakes

You can see the direction and speed with which targets are moving relative to your vessel by selecting the target wakes display option.



When wakes are switched on, the target is displayed at the brightest level and the previous positions of targets are retained at successively fainter levels on the screen. You can select long, medium or short wakes, which retain information from previous scans at a reduced video level.



You can clear existing wakes from the display by pressing the CLEAR WAKES soft key. The soft key is only available when wakes are switched on; the display starts showing new wakes as soon as the old wakes have been cleared.

When wakes are switched off, no new wakes are displayed and existing wakes are cleared.

3.4 Measuring Range and Bearing Using VRM/EBLs

The Pathfinder Plus Radar display allows you to specify up to two Electronic Bearing Lines (EBLs), each with an associated Variable Range Marker (VRM), using the **VRM/EBL** key.

A standard VRM is displayed as a circle with its centre on your vessel's position, and its EBL is displayed as a line from the origin to the edge of the radar picture display. However, each pair can be *floated*, so that the origin can be moved.

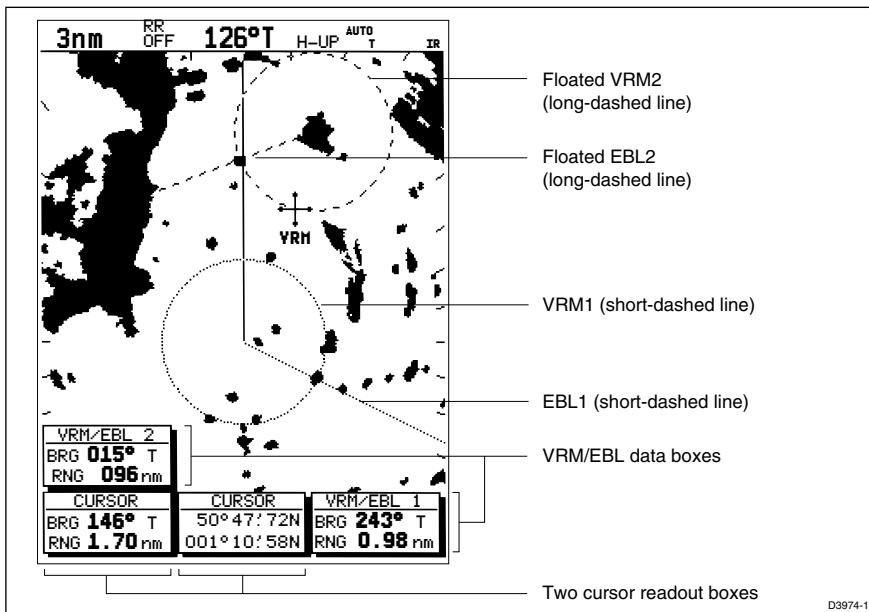

Figure 3-11: EBL and VRM Displays

Note: When using VRM/EBLs, you may wish to turn off the range rings to make the VRMs clearer (see Section 2.4).

VRMs move if you change the range scale, so that the actual range you have marked is maintained. VRM/EBLs also move if you offset the centre.

When a VRM/EBL pair is active, its bearing and range are displayed in its associated data box, which can be moved, deleted or reinstated.

The bearing information is displayed as either the bearing relative to your vessel's heading or (if heading data is available from a position fixer or compass) the actual bearing in degrees magnetic or degrees true. These are controlled by the setup parameters (see Section 7.4).

The VRM/EBL functions allow you to perform the following tasks:

- Measure the range of a target or point from your vessel's position, using a VRM

- Measure the bearing of a target or point from your vessel's position, using an EBL
- Measure the range and bearing between any two points on the radar, using the FLOAT function

Note: *An alternative method of measuring range and bearing is to use the cursor data box: If the cursor readout is set to display range and bearing (rather than Lat/Long), you can determine the range and bearing by moving the cursor over the target and checking the cursor data box readings. You can also estimate the range to a target by reference to the range rings.*

Measuring Range and Bearing to Target from Vessel

To measure the range and/or bearing of a target or point from your vessel's position, you need to place a VRM/EBL and move it so that it crosses the target or point for which you require the bearing or range.

When you turn on a VRM/EBL, it is displayed in its last-used position.

Note: *If the VRM's last-used position is outside the radar picture at the current range setting, it is placed at its default position instead. This is one third of the range for VRM1, and two-thirds for VRM2.*

Placing a VRM/EBL

Placing and positioning VRM/EBLs on the Pathfinder Plus Radar display is quick and easy.



- If a VRM/EBL is not already displayed, you can place one with a single press of the **VRM/EBL** key.
- If you have already placed a VRM/EBL, pressing the **VRM/EBL** key provides soft key control of additional functions.

► To place a VRM/EBL when one is not already displayed:



1. Press **VRM/EBL**.

The radar picture shows VRM/EBL1, together with its associated data box in its last-used position.

As shown in *Figure 3-12*, the cursor is positioned over the intersection of the VRM circle and the EBL line. It has control of the VRM/EBL as indicated by the four-way arrow, the solid VRM/EBL line, and the text VRM/EBL.

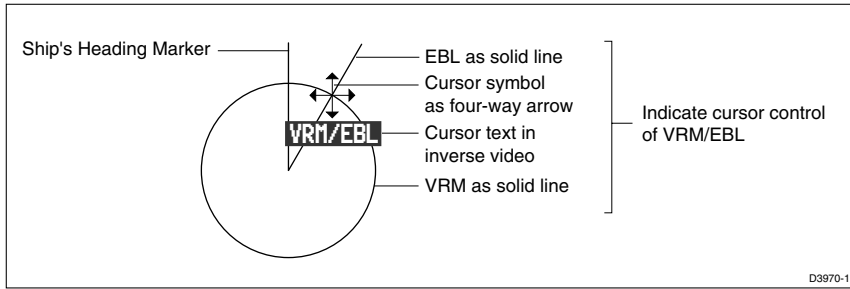

Figure 3-12: Placing a VRM

2. If required, use the trackpad controls to change the radius (range) of the VRM circle and the angle of the EBL until they cross the required target. The range and bearing information in the VRM/EBL data box is updated as you move the cursor.
3. Press **ENTER** to drop the VRM/EBL. The radar shows this VRM/EBL as a short-dashed line, and the cursor returns to normal control.
4. Read the range and bearing to the target or point, which is shown in the VRM/EBL data box.
5. If required, you can move or delete the VRM/EBL data box using the context-sensitive cursor.

➤ To place a VRM/EBL when one is already displayed:

1. Press **VRM/EBL** to display the VRM/EBL soft keys.



The labels for the two left-hand soft keys indicate the current status of the two VRM/EBLs.



2. Press the soft key for the VRM/EBL you require, to toggle the setting from OFF to ON. The soft key labels are cleared, and the radar picture shows the VRM/EBL and its associated data box.
3. Position the EBL/VRM using the trackpad, and press **ENTER** to drop it. The radar shows the VRM/EBL as a short-dashed line (VRM/EBL1) or a long-dashed line (VRM/EBL2), and the cursor returns to normal control.

Moving an Existing VRM/EBL

You can move an existing VRM/EBL using the context-sensitive cursor. You can control the VRM and EBL separately or both together.

- To move the VRM and/or EBL:
 1. Move the cursor over the VRM or EBL you wish to change. If you wish to change the VRM and EBL together, move the cursor over the intersection of VRM/EBL. The cursor text indicates the current object as VRM, EBL, or VRM/EBL.
 2. Press **ENTER** to take control of the object. The object(s) under control is displayed as a solid line, and the cursor as a four-headed arrow.
 3. Move the EBL to the new angle and/or change the VRM radius (range) using the trackpad controls.
 4. Press **ENTER** again to drop the VRM/EBL in its new position, or **CLEAR** to abandon the operation and return the VRM/EBL to its previous position.

The radar shows the VRM/EBL as a short-dashed line (VRM/EBL1) or a long-dashed line (VRM/EBL2), and the cursor returns to normal control.

Deleting an Existing VRM/EBL



- You can delete a VRM/EBL by using the **VRM/EBL** key to display the soft keys, and pressing the required VRM/EBL soft key to toggle the setting from ON to OFF.
- Alternatively, you can delete an existing VRM/EBL using the context-sensitive cursor. To do so:



1. Move the cursor over the VRM/EBL you wish to control, until the letters VRM, EBL, or VRM/EBL are displayed.
2. Press **CLEAR**.

This has the same effect as turning the VRM/EBL off using the VRM/EBL soft keys. It turns off the VRM/EBL pair, irrespective of the cursor text: you cannot turn off VRMs and EBLs independently.

Measuring Range and Bearing Between Targets (FLOAT)

You can measure the range and bearing between any two points on the radar, such as two targets, using the Pathfinder Plus Radar's Float function. This allows you to move the origin of a VRM/EBL away from your vessel's position and onto a target. You can then change the angle of the EBL, relative to its new origin, to obtain the bearing between two points. The radius of the VRM can also be adjusted to determine the distance between two points.

Floating a VRM/EBL

Note: You can float a VRM/EBL pair using either the soft keys or the context-sensitive cursor. The procedure for using the cursor is the same as for moving

or unfloating a VRM/EBL pair, as described below; however, as it is more difficult to locate the VRM/EBL origin when it is over the centre, you will probably find it easier to use the keys in this case.

- To float a VRM/EBL pair using the keys:
 1. If one is not already present, place a VRM/EBL pair as described in the previous section.
 2. Press **VRM/EBL** to display the VRM/EBL soft keys.
 3. Press the **FLOAT** soft key. The soft keys are updated, with the relevant options displayed.

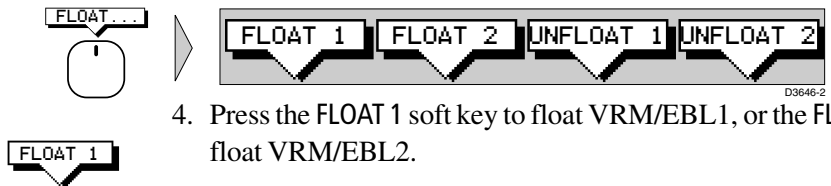

4. Press the **FLOAT 1** soft key to float VRM/EBL1, or the **FLOAT 2** soft key to float VRM/EBL2.

The soft keys are cleared. The cursor is positioned over the origin of the VRM/EBL, over your vessel. The cursor has control of the VRM/EBL, as indicated by the four-headed arrow, the text **FLT** in inverse video, and the solid VRM/EBL line.

5. Use the trackpad to move the origin of the VRM/EBL to the required position (over the first target).
6. Press **ENTER** to drop the VRM/EBL in its new position, or **CLEAR** to abandon the operation and return the VRM/EBL to its previous position.

The radar shows the VRM/EBL as a short-dashed line (VRM/EBL1) or a long-dashed line (VRM/EBL2), and the cursor returns to normal control.

7. Use the context-sensitive cursor to take control of the VRM and/or EBL, to obtain the range and/or bearing to a second target, as previously described.
8. Read the range and bearing information from the VRM/EBL data box.



Moving and Unfloating a Floating EBL

You can move or unfloat a VRM/EBL that has been floated. You can unfloat a VRM/EBL either by using the context-sensitive cursor or by using the **FLOAT** soft key options.

- To move or unfloat a floating VRM/EBL using the cursor:
 1. Move the cursor over the origin of the VRM/EBL you wish to control, until the letters **FLT** are displayed.
 2. If you wish to unfloat the VRM/EBL, press **CLEAR**. The origin of the VRM/EBL is reset to your vessel's position.



- Alternatively, if you wish to move the floating VRM/EBL, press **ENTER** to take control of it and move it using the trackpad.

Press **ENTER** again to drop the VRM/EBL in its new position, or **CLEAR** to abandon the operation and return the VRM/EBL to its previous position.

- To unfloat a floating VRM/EBL using the keys:

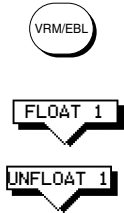

- Press **VRM/EBL** to display the VRM/EBL soft keys.
- Press the **FLOAT** soft key.
- Press the **UNF LOAT 1** soft key to unfloat VRM/EBL1, or the **UNFLOAT 2** soft key to unfloat VRM/EBL2.

The soft keys are cleared, and the VRM/EBL is repositioned with its origin at your vessel's position.

Controlling VRM/EBL Data Boxes

- To move a VRM/EBL data box, using the context-sensitive cursor:



- Move the cursor over the box until the letters **BOX** are displayed, and press **ENTER** to take cursor control of the box.
- Use the trackpad to move the box to its new location, and press **ENTER** to drop it and return to normal cursor operation.

Each VRM/EBL data box is switched on and off with its associated VRM/EBL. However, when one or both VRM/EBLs are active, you can turn the data box(es) off at any time, if required.

- To control the VRM/EBL data boxes:

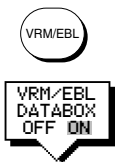

- Press **VRM/EBL** to display the **VRM/EBL** soft keys.
- Press the **VRM/EBL DATABOX** soft key to toggle the setting from **OFF** to **ON** or from **ON** to **OFF**.

Note: *VRM/EBL data boxes are not affected by the setting of the DATABOXES soft key accessed using the SCREEN default soft key. This only controls the set of data boxes available for integrated systems (see Chapter 2).*

3.5 Setting Guard Zones and Alarms

The Pathfinder Plus Radar display allows you to set up one or two guard zones, using the **ALARMS** key. You can set up sector zones or 360° (circular) zones as shown in *Figure 3-13*.

Note: *You can only view and control guard zones if you are using the Master display (that is, the display to which the scanner is connected).*

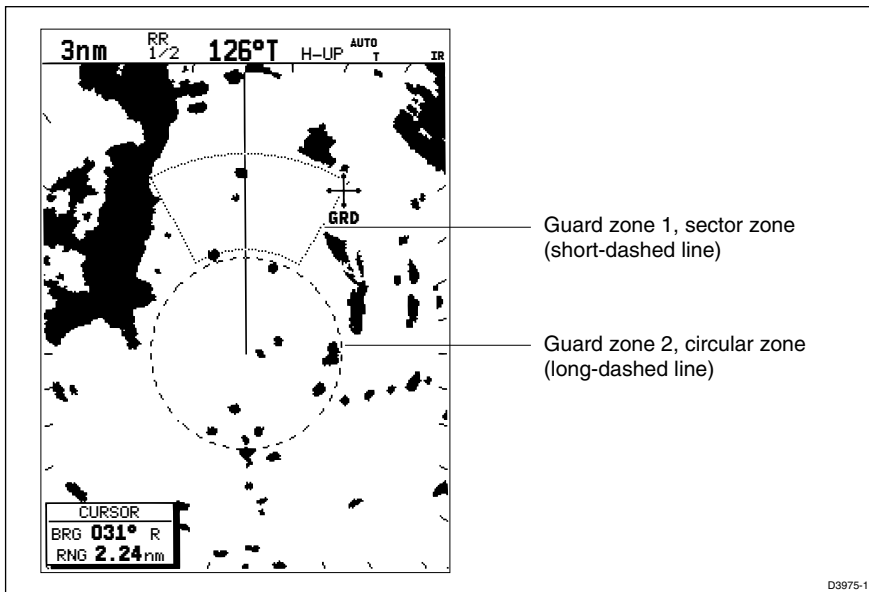

Figure 3-13: Guard Zone Display

Guard zones are fixed with respect to the ship's heading marker (SHM), moving as the SHM moves. They also move if you offset the centre, or if you change the range scale, so that the area you have marked is maintained.

The guard alarm sounds when a target enters a guard zone, exceeding the target density threshold within the zone; the alarm also sounds on a repeater display. The alarm sensitivity control allows you to set the threshold above which a new target will trigger an alarm, and also to turn the alarm on or off.

Note: *A guard zone only operates when the whole zone is displayed on the screen, or could be displayed by offsetting the centre. In addition, a guard zone is inactive for 10 seconds after it is placed or re-sized, to avoid inappropriate alarms during positioning.*

This section covers the following topics:

- Placing a guard zone
- Moving, reshaping or deleting a guard zone
- Controlling guard zone alarms

Placing a Guard Zone

Placing and positioning guard zones on the Pathfinder Plus Radar display is quick and easy.

- If a guard zone is not already displayed, you can place one using the **ALARMS** key.
- If you have already placed a guard zone, pressing the **ALARMS** key allows you to toggle either guard zone on or off.

Note: When you turn on a guard zone, it is normally displayed in its last-used position and shape. However, if this position is off-screen at the current range setting, or within one quarter of the current range from your vessel, the guard zone is placed at its default position and shape instead. This is at one third (Zone 1) or two thirds (Zone 2) of the current range, as a sector zone occupying 30° either side of the ship's heading marker.

- To place a guard zone:
 1. Press **ALARMS**. The soft keys are displayed.



The soft keys indicate the current status of the two guard zones.

2. If necessary, press the soft key for the guard zone you require, to toggle the setting between OFF and ON. The soft keys are cleared. If you turned a guard zone on, it is displayed in its last-used position with one corner under cursor control.



The radar picture shows the guard zone as a four-sided shape bounded by a solid line (or a circle if previously set as one).

The cursor is positioned over an outer corner of the zone as shown in *Figure 3-14*. The cursor has control of this corner, as shown by the text **GRD** in inverse video, the four-headed arrow, and the solid guard zone boundary.

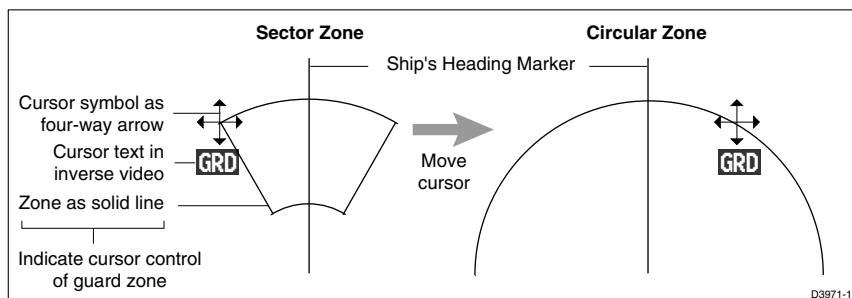

Figure 3-14: Placing a Guard Zone

3. If necessary, use the trackpad to move the corner of the guard zone to the required position. As you move the corner, the width and/or height of the zone changes, but its general sector shape is retained.

Note: *To create a 360° guard zone, rather than a sector guard zone, you can either move the corner all the way round to form a circle, or move it back to just the other side of the other outer corner.*

4. Press **ENTER** to drop the corner in its new position and redraw the zone, or **CLEAR** to abandon the operation and return the corner to its previous position.

The display shows this zone boundary as a short-dashed line (zone 1) or a long dashed line (zone 2), and the cursor returns to normal control.

5. If required, use the context-sensitive cursor to reposition other corners/sides of the zone in turn, as described below.

Moving, Reshaping or Deleting a Guard Zone

- You can move, reshape or delete an existing guard zone using the context-sensitive cursor. To do so:



1. Move the cursor over the guard zone corner or side that you wish to control, until the letters GRD are displayed.
2. If you wish to delete the whole zone, press **CLEAR**.
3. Alternatively, if you wish to move the corner or side, press **ENTER** to take control of it. The zone boundary is displayed as a solid line, and the cursor as a four-headed arrow.
4. Move the corner or side to the new position, as described on the previous page.

Note: *To convert a 360° guard zone back to a sector guard zone, take control of any point on the circle, and move it to open up the circle.*

5. Press **ENTER** again to drop the corner or side in its new position, or **CLEAR** to abandon the operation and return it to its previous position

The radar shows the zone boundary as a short-dashed line (Zone 1) or a long-dashed line (Zone 2), and the cursor returns to normal control.

6. If required, reposition the cursor and repeat steps 3 to 5 to move the other corners or sides.

- You can also delete (turn off) a zone by pressing the **ALARMS** key, and then pressing the appropriate guard zone soft key to toggle the setting from ON to OFF.



Controlling Guard Zone Alarms

The guard alarm is triggered when a target enters a guard zone which exceeds the target density threshold. You can set the threshold above which a new target will trigger an alarm, and can also turn the alarm on or off.

When the alarm is triggered, the unit beeps and a text message is displayed.

- To clear the alarm, press **any** key (on the master or repeater display).

The alarm will sound again after 10 seconds, unless one or more of the following happens:

- You turn the guard zone off
- You adjust the guard zone size/shape to reduce the number of targets in the zone
- You turn the alarm off
- You decrease the alarm sensitivity
- The target leaves the guard zone

- To change the alarm sensitivity setting:

1. Press **MULTI** to display the sliders.

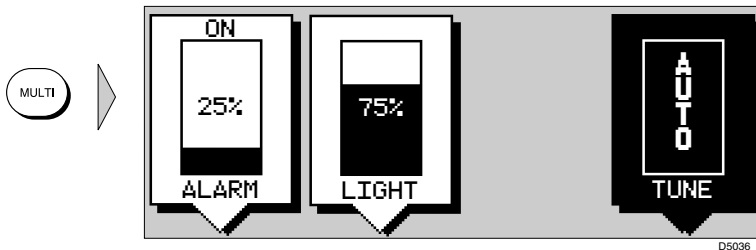

2. Press the ALARM soft key to highlight the Alarm slider.
3. If required, press the soft key again to toggle the setting between OFF and ON. You can only move the slider if the control is set to ON.
4. Use the trackpad to increase or decrease the alarm slider setting. You can press and hold the trackpad to change the value more rapidly.
5. The higher the setting, the more sensitive the alarm, and the smaller the target density required to set it off.
6. Press **ENTER** to clear the slider display.

3.6 MARPA

Introduction to MARPA

The *hsb²* series displays include a MARPA (Mini Automatic Radar Plotting Aid) function for target tracking and risk analysis. This section gives an introduction to the Pathfinder Plus Radar MARPA system and shows you how to use the MARPA functions, you should also read *Section 7.5*.

MARPA improves the standard of collision avoidance by obtaining detailed information for several automatically tracked targets. MARPA provides continuous, accurate and rapid situation evaluation.

You can acquire up to ten targets, which are then automatically tracked by the MARPA system. MARPA calculates target bearing and range, true speed and course, CPA (Closest Point of Approach), and TCPA (Time to Closest Point of Approach).

Each tracked target can be displayed with a vector depicting approximate target speed (vector length) and course (vector direction). The calculated target data can also be shown on the screen. Each target is continually assessed and you are warned if one becomes dangerous or is lost.

Effective MARPA operation is dependent on accurate own ship's heading, plus SOG and COG. The better the quality of the heading data, the better MARPA will perform. (MARPA functions without SOG and COG data but only relative vector, CPA and TCPA are shown; target course and speed cannot be calculated). For more information on heading sensors, and how to connect them to your display, refer to *Heading and Position Data* on page 1-9 and *Appendix E*.

SAFETY NOTICES

MARPA can improve collision avoidance when used wisely. It is the user's responsibility to exercise common prudence and navigational judgements.

There are conditions where acquiring a target may become difficult. These same conditions may be a factor in successfully tracking a target. Some of the conditions are:

- The target echo is weak.
- The target is very close to land, buoys or other large targets.
- The target or your own ship is making rapid manoeuvres.
- Choppy sea state conditions exist and the target is buried in excessive sea clutter or in deep swells.

- Choppy sea state conditions exist yielding poor stability; own ship's heading data is very unstable.
- Inadequate heading data

Symptoms of such conditions are that acquisition is difficult and the MARPA vectors are unstable; the symbol wanders away from the target, locks onto another target or changes to a lost target symbol. If any of these conditions are present, acquisition and tracking may need to be re-initiated or, in some cases be impossible to maintain. Improving the quality of the heading data will reduce the effect of the other conditions.

Risk Assessment

Each target is monitored to see if it will be within a certain distance from your own vessel within a certain time. If so, the target is designated as dangerous and you are warned with an audible alarm in addition to a warning on the screen. The target symbol changes and flashes to indicate that it is a dangerous target. Pressing any key silences the alarm and removes the warning, but the target symbol remains dangerous.

Both the distance (Own Vessel Safe Zone) and the time (Time to Safe Zone) are selectable as described in *Section 7.5*.





If a target is lost, either because the MARPA software has lost contact with it, or because it has moved out of range, you are warned, again with an audible alarm and an on-screen warning. Pressing any key silences the alarm, removes the warning and removes the lost target symbol from the screen.

Target Data

All MARPA targets are stored in a MARPA database list, which shows bearing, range, course and speed of each tracked target.

For any one target a pop-up data box can be placed on the screen, this shows bearing, range, course, speed, CPA (Closest Point of Approach) and TCPA (Time to Closest Point of Approach). The target for which data is displayed is indicated by a circle around its symbol.

Each target is displayed as a symbol to indicate its status:

-  Target is being acquired
-  Target is safe
-  Target is dangerous.
-  Target is Lost

The dangerous and lost symbols are shown flashing.

Target Vector and History

The MARPA targets can be displayed with a vector line showing where they will be at a certain time in the future, (assuming present course and speed). You can select a relative or true vector and the vector length. The vector type (RV or TV) and length are shown in the status bar.

You can also select to view the target's history, this appears as a series of dots that are dropped by the target as it makes way. The interval between them is selectable.

A **relative vector** indicates the target's motion related to your own ship's motion. The target's relative course and speed are calculated to produce a vector that is displayed on the target only. This mode is used for collision avoidance and threat assessment.

A **true vector** indicates the target's motion over ground. In this mode true vectors for the target and your own ship are displayed. MARPA measures the direction in which the target and own ship are actually moving over the ground. The result is the vessel's *true course*, the rate of motion is the vessel's *true speed*. Consider this motion as if you were in a helicopter looking down watching the targets move across the water. This mode can aid navigation.

Section 7.5 describes how to set the target vector and history parameters.

Repeater Displays

On an integrated *hsb²* display system the repeater display (with the appropriate software version) can access the MARPA functions, and targets are shown on the repeater display. MARPA data is also sent on NMEA allowing any other equipment, with the necessary functionality, to show the tracked targets' data.

Radar Range Scales

MARPA target acquisition is only available at radar range scales of up to 12nm, although tracking continues at all ranges.

Note: *If you change to a lower range scale, targets may be beyond the range of the scanner and will be lost. In such cases an alarm pop-up indicates the target is off-screen.*

Using MARPA

The MARPA functions are accessed through the MARPA default soft key, and some options are available with the context sensitive cursor, or through the MARPA database list. Where there are two ways of performing a certain function this section describes both ways. Information on how to set up the MARPA system is in *Section 7.5*.



D4126_1

Acquire a Target

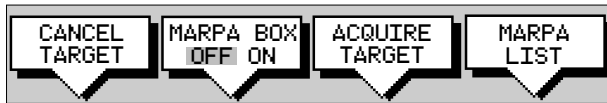

➤ To acquire a target:

1. Press the MARPA soft key to display the ACQUIRE TARGET soft keys.



D4120_1

2. Position the cursor over the required target and press the ACQUIRE TARGET soft key.

The  symbol is placed at the cursor position and the radar searches for a target at the cursor position. If a target is present for several scans the radar locks onto it and the symbol  indicates a safe target, the target vector is also displayed. If the target is continuously lost, the lost target symbol  is displayed and a Lost Target alarm is generated; press any key to cancel the alarm and remove the lost target symbol from the display.

3. Press **ENTER** or **CLEAR** to return to the default display.

Cancel a Target

➤ To cancel a target using the context-sensitive cursor:

1. Move the cursor over the target, the following soft keys are displayed.



D4119_1

2. Press the CANCEL TARGET soft key to cancel target tracking and remove the symbol from the display. The default soft keys are displayed.

➤ To cancel a target from the database list.

1. Press the default soft key MARPA to display the MARPA soft keys.
2. Press the MARPA LIST soft key, the database list is displayed.
3. Use the trackpad to select a target, then press the CANCEL TARGET soft key to remove the selected target.
4. Press **CLEAR** to remove the database list.

View Target Data

You can toggle the MARPA data box on/off using the MARPA BOX ON/OFF soft key. This box displays the data for one MARPA target. You can select the



target using the context sensitive cursor or the database list. Alternatively, if you display the data box when no target is selected, data is displayed for the last target that had the data box displayed – unless a new target has been acquired, then the new target data is displayed.

- To view (or hide) target data using the context sensitive cursor:
 1. Move the cursor over the target for which you require data. The letters MARPA and the following soft keys are displayed.



2. Press the MARPA BOX ON/OFF soft key to toggle the data box on/off for the selected target. The target data box is displayed and the associated target symbol is identified by a circle drawn around it. The default soft keys are displayed when you move the cursor away from the target.

Note: When you select ON, if the data box was already displayed for another target, it is updated for the selected target.

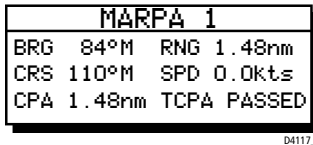

Figure 3-15: MARPA Target Data Box

- To view (or hide) target data using the default soft keys:
 1. Press MARPA to display the MARPA soft keys.
 2. Press the MARPA BOX ON/OFF soft key to toggle the data box on. The target data box is displayed and the associated target symbol is identified by a circle drawn around it. The default soft keys are displayed.
 3. Press the MARPA BOX ON/OFF soft key again to toggle the data box off.



- To view the MARPA database list and a target data box:



1. Press MARPA followed by the MARPA LIST soft key, the database list is displayed.
2. Use the trackpad to select a target, then press the MARPA BOX ON/OFF soft key to toggle the data box on/off.
3. Press **CLEAR** to remove the database list.

MARPA				
ID	BRG	RANGE	COURSE	SPEED
0	327°T	0.63nm	256°T	3.0kts
1	537°T	1.70nm	256°T	2.0kts

CANCEL TARGET MARPA BOX OFF ON CANCEL ALL

D4121-1

Figure 3-16: MARPA Database List

► To cancel *all* targets:



1. Press MARPA followed by MARPA LIST to display the database list.
2. Press the CANCEL ALL soft key. You are prompted to confirm.
Press YES to continue, all the MARPA targets are cleared from the screen, and the data is removed from the MARPA database list.
Press NO to cancel the operation.

Chapter 4: Integrated Radar Operations

4.1 Introduction

This chapter explains how to use and display non-radar information that may be available from other units connected to your system. It also explains how to use the man overboard (MOB) function. You can use this chapter with the radar display set to *simulator mode*, or on the water after you have installed and set up your *hsb²* (PLUS) series Pathfinder Radar system.

In order to use these functions, you need the following additional data from equipment connected to your system via a SeaTalk, NMEA or *hsb²* link:

Table 4-1: Function of External Data

Data	Example source	Integrated functions available
Heading	Compass* Autopilot	- Heading value in status bar - North Up or Course Up heading modes (as alternatives to Head Up) - MOB (if speed data also available)
	Rate Gyro Compass on NMEA	- MARPA - Radar/Chart Overlay
*If heading data is available via both NMEA and SeaTalk, NMEA data takes priority. For all other data, SeaTalk data takes priority (see).		
Waypoint data	Chartplotter	- Waypoint display and data
Position	GPS system	- Marks - Position data in Data Box and Nav Window - MOB - COG, SOG and time - Radar/Chart Overlay
Other data	Transducers	- Data Box and Nav Window data displays including speed, depth, wind
Chart display	Chartplotter, either combined or via <i>hsb²</i> connection	- Chart display as full-screen or half-window display

This chapter covers the following topics:

- Changing the heading mode of the radar picture
- Using marks
- Man Overboard (MOB)
- Cursor echo

Note: *Until you are familiar with interpreting the radar display, you should take every opportunity to compare the radar's display patterns with visual targets, such as other vessels, buoys and coastal structures. You should practice harbour and coastal navigation during daylight and in clear weather conditions.*

4.2 Changing the Heading Mode

The radar picture is normally shown with your vessel's dead ahead bearing straight up, as indicated by the Ship's Heading Marker at 0° relative bearing. This is the Head Up orientation.

If heading information is available via a SeaTalk or NMEA connection, you can choose a different heading mode. In Course Up and North Up mode you can also select relative or true motion.

True and Relative Motion

Relative motion is the default for the radar display. In relative motion your own ship's position remains fixed on the radar screen and all radar targets move relative to your own ship.

In true motion, fixed radar targets maintain a constant position on the screen, whilst your own ship moves across the radar image at the appropriate speed and heading. A map-like image is thus displayed, with all moving vessels travelling in true perspective to each other and to fixed land masses.

As your ship's position approaches the edge of the screen, the radar display is automatically reset to reveal the area ahead of your ship. You can manually reset your ship's position at any time by pressing the TRUE REL soft key twice.

Heading Modes

The heading modes are as follows:

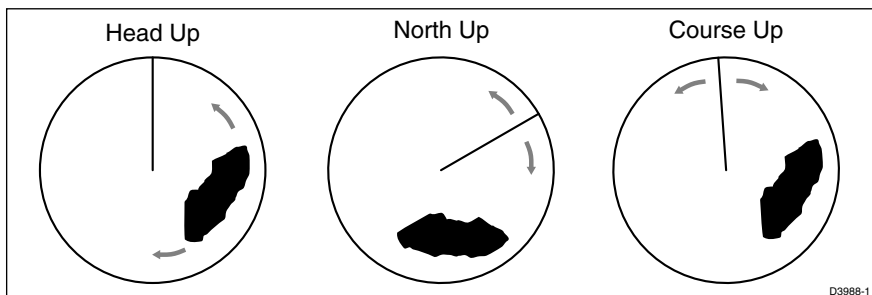

Figure 4-1: Radar Heading Modes

- **Head Up:** The radar picture is displayed with the vessel's current heading upwards. As the heading changes the picture will rotate.
- **North Up:** The radar picture is stabilized and displayed with north upwards. As you change heading, the ship's heading marker moves.
- **Course Up:** The radar picture is stabilized and displayed with the currently selected course upwards. As you change heading, the ship's heading marker moves. If you select a new course, the picture resets to display the new course upwards.

The reference used for the Course Up depends on the information available. The first available in the following list is used:

1. A locked heading (i.e. the heading being used by an autopilot) over a SeaTalk connection
2. The heading at the time Course Up was selected

If 1. is in use and a new course (locked heading) is selected, the picture automatically rotates to the new Course Up.

If 2. is in use, press the HDG MODE soft key then COURSE UP to manually reset the Course Up to the new course.

Selecting the Heading and Motion Mode

Press the HDG MODE default soft key to obtain the following display, when heading information is available:



The currently selected mode is highlighted, and is indicated in the radar status bar (N-UP, C-UP or H-UP and TM or RM).

- To change the heading and motion mode:
 1. Press the HDG MODE default soft key.
 2. Press the soft key corresponding to the mode you require. The radar picture changes to the selected mode.
 3. Press **ENTER** to clear the heading mode soft keys. The current orientation is indicated in the status bar.

Note: *True Motion is only available in Course Up and North up mode.*

If you re-select Course Up when this is already the current mode, the Course Up reference is reassessed according to the current data.

Effect on VRM/EBLs

VRM/EBLs do not move on the screen, unless you change the range, offset the centre, or change the heading mode.

- In Head Up mode, the VRM/EBLs are fixed with respect to the ship's heading marker.
- In North Up mode, the VRM/EBLs are fixed with respect to North.
- In Course Up mode, the VRM/EBLs are fixed with respect to the selected course.

4.3 Using Marks

The Marks function allows you to place a mark anywhere on the radar picture. You can also move existing marks or delete them. You should be aware that radar marks are not the same as chart waypoints and cannot be used in routes, nor can they be transferred to other displays.

Marks are placed with the default mark symbol  at either cursor or vessel position. If you wish to use a different symbol, you can change the default setting from the RADAR SET UP menu (see *Section 7.4*). Mark symbols are always displayed within a circle.

Marks are stored with their latitude, longitude and symbol; the information is retained when the radar is turned off. Up to 100 marks can be stored in each display unit.



Note: When you use the **MARKS** key to access the Marks function, simply press the key momentarily and release it. If you hold it down for two seconds, the Pathfinder Radar will enter man overboard (MOB) mode, as described in *Section 4.4*.

The Marks function is only available when your vessel's position is known via the SeaTalk or NMEA connection.

Placing a Mark

➤ To place a mark symbol:



1. Press the **MARKS** key. The soft keys PLACE MRK AT CURSOR and PLACE MRK AT VESSEL are displayed.
2. To place a mark at the cursor, position the cursor at the required point. If you are displaying the cursor position box showing the lat/long position, you can check the coordinates to place the mark accurately. Press the PLACE MARK AT CURSOR softkey. The mark is placed using the default symbol.
3. To place a mark at the vessel position, press PLACE MRK AT VESSEL. The mark is placed using the default symbol.



Note: If the Mark database is full, a warning message is displayed, with the position (in latitude and longitude) of the oldest mark. You have the following options:

- i. Press the YES soft key to replace this old mark with the new mark.
- ii. Press the NO soft key to keep the old mark and display the next oldest mark. You can keep pressing NO to step through the mark database until a mark you wish to replace is displayed, and then press YES.
- iii. Press **CLEAR** to keep all the existing marks, and cancel the new mark placement.

Moving or Deleting a Mark

You can move or delete marks using the context-sensitive cursor.



- If you have placed a mark and wish to move it later:
 1. Move the cursor over the mark until the letters **MRK** are displayed.
 2. Press **ENTER** to take control of the mark.
 3. Move the mark to the new position using the trackpad.
 4. Press **ENTER** again to drop the mark in its new position, or **CLEAR** to abandon the operation and return the mark to its previous position.
- To delete an individual mark, move the cursor over the mark until the letters **MRK** are displayed, then press **CLEAR**.

4.4 Man Overboard (MOB)

If you lose a person or object overboard, and need to return to the location, you should use the Man Overboard (MOB) function immediately.

Note: *To obtain an MOB position, you need either of the following:*

- Position data from a GPS or equivalent device
- Heading and speed data, so that the position can be calculated by dead reckoning

You can select the type of data used for the MOB position using the Set Up Menus (see *Section 7.3*).



- To initiate the MOB procedure, press and hold the **MARKS** key for two seconds.

The Pathfinder Plus Radar then performs all the following tasks automatically:

- Marks the current position with a MOB  symbol.
- The MOB waypoint replaces any current active waypoint and route.
- Displays the MOB data box, showing the bearing and distance from your vessel to the MOB waypoint position, and the elapsed time since the MOB was initiated.
- Displays the position data box, showing your vessel's position.
- As your vessel moves away from the MOB position, a dotted line is displayed connecting the MOB position and the vessel's current position.
- Sounds a 4-second alarm pattern every 30 seconds.
- Sends an MOB message to other units in the system, via the SeaTalk connection.

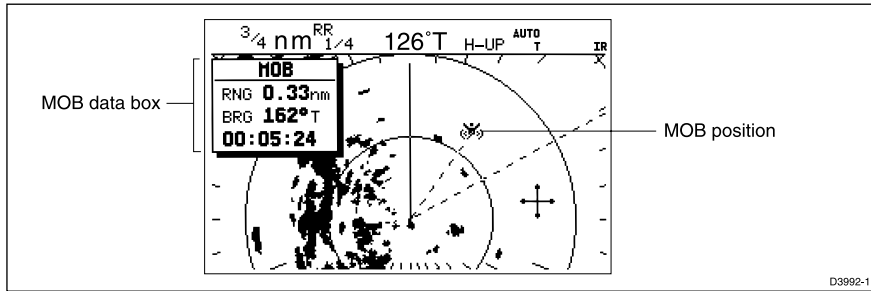

Figure 4-2: MOB Alarm



- To cancel the MOB, press and hold the **MARK** key for 2 seconds.

Note: *The MOB procedure can also be initiated or cancelled remotely if the appropriate SeaTalk message is received by the Pathfinder Radar.*

4.5 Cursor Echo

In a combined radar/chart display, or in a system with any chart display connected via Seataalk, you can set the display to enable cursor transfer. Cursor echo (accessed from the Set Up Menu) enables you to display a chart cursor on the radar picture, or a radar cursor on the chart picture (you cannot display a remote radar cursor in a radar window, nor a remote chart cursor in a chart window).

The following options are provided:

- **Radar Cursor In:** displays the cursor from another radar on the chart display or chart window (default - OFF).
- **Chart Cursor In:** displays the cursor from another chartplotter on the radar display or radar window (default - OFF).

Note: *The remote display must have SeaTalk Cursor Out enabled.*

*Raymarine recommend that in multi-display systems, you do **not** enable Cursor Out on more than two displays. If multiple displays have cursor out enabled, the cursors will not be displayed simultaneously, but will flash on/off.*

- **SeaTalk Cursor Out:** enables the output, onto SeaTalk, of the display's own cursor (default - OFF).
- **Cursor Echo Local:** echoes the cursor position between open windows on the same display (default - ON).

When the appropriate option is switched on, the display shows its own cursor, plus the cursor of the other display(s) with appropriate cursor text (RDR or CHT) to indicate its origin. This means that you could move the cursor over a target on the radar display, and check the identity of the target by looking at the radar cursor position on the chartplotter.

Refer to *Section 7.3* for cursor echo setup details.

Chapter 5: Standard Chart Operations

5.1 Introduction

This chapter explains how to use the chart functions to navigate with your *hst²* series display. It covers the following topics:

- Using chart cards.
- Controlling waypoints, including placing, moving, editing and deleting waypoints.
- Working with routes, including creating a new route, managing routes using the route database and editing routes.
- Following routes and going to waypoints.
- Transferring Waypoints and Routes
- Using tracks, including showing tracks, setting up tracks, saving tracks and creating a route from a track (SmartRoute).

All these chart functions are available in plotter mode, so you can plot and track routes at large scales even when a chart card is not installed.

Further functions, including measuring distances and setting alarms are described in *Chapter 6*.

Safety

The chartplotter makes it very easy to place a waypoint and travel towards it. However, you should always check first that the route is safe. If you are using the chartplotter in combination with a SeaTalk autopilot, the autopilot will prompt for confirmation before it steers the vessel towards the waypoint.

If you have entered your route using a small-scale chart, zoom in to a larger scale to check for hazards, such as small shoals, that may not be shown on the smaller scale charts.

Note: *Until you are familiar with interpreting the chart display, you should take every opportunity to compare the displayed objects with visual targets, such as buoys and coastal structures. You should practice harbour and coastal navigation during daylight and in clear weather conditions.*

CAUTION:

The equipment should not be used as a substitute for good navigational practice nor for official government paper charts.

5.2 Using Chart Cards

The chartplotter has a built-in world map; most areas are displayed on a scale of 4000 nm from the top to the bottom of the screen, and can be zoomed in to 150 nm.

To use the chartplotter as a navigation aid, charts with detailed information for the area you wish to navigate are required. The charts are available on C-MAP NT electronic chart cards (C-Cards), each of which can store as many as 20 charts in an electronic format. A single C-MAP chart normally provides as much information as is available in paper charts for that geographic area, and can be displayed down to a range of 1/64 nm on the screen if the data is available.

Two card slots are provided on the display unit. Chart data from both slots can be downloaded.

The chart scale in use is indicated in the status bar - the number represents the distance (in nautical miles) displayed from the top of the chart window to the bottom of the chart window.

Note: *You can remove and insert cards while a chart is displayed. The chart information is retained on-screen until the chartplotter redraws the screen: for example, when you pan outside the current area, or use the **RANGE** key to change the chart scale.*

Data on a chart card is also available to a repeater display, where it can be used independently of the master; a display on hsb² can access up to six remote chart cartridges. When the master display is switched off chart data is retained on the repeater screen until the chart is redrawn.

Inserting a Chart Card

- To insert a chart card:
 1. Check that the card is a C-MAP NT C-Card with the required chart stored on it.
 2. Open the card cover, at the lower left of the display front panel.
 3. Hold the card with the title label towards the left, as shown in the illustration.
 4. Gently push the card into one of the two slots. It will only go in if it is correctly oriented. Push the card in as far as it will go, then move it to the right so that the top is under the retaining pegs. The card will be held in place by the pegs.
 5. Close the card cover until it clicks shut, to prevent water entering the display unit.

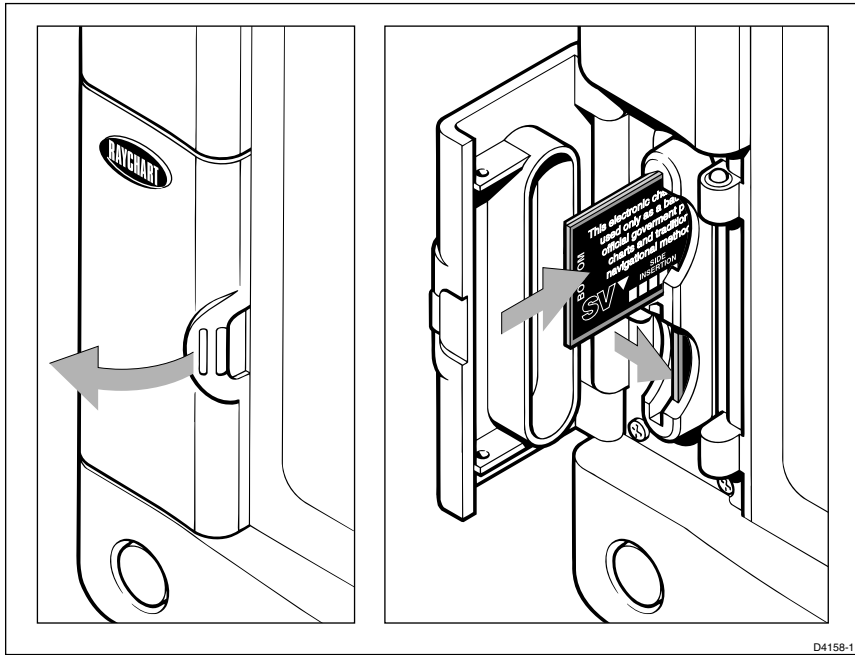

Figure 5-1: Removing the Chart Card

Removing a Chart Card

We recommend that before you remove a chart cartridge, you ensure the chart is not being used on any other display unit. Removing a chart cartridge whilst a display unit is accessing the chart may cause an operational error.

► To remove a chart card:

1. Open the card cover, at the lower left of the display front panel.
2. Press on the card you wish to remove, and move the top of the card to the left to clear the retaining pegs.
The card will spring half-way out, enabling you to grip the card and remove it from the slot.
3. Remember to close the card cover so that it clicks shut, to prevent water from entering the card reader assembly.

Displaying the Chart Data

The new chart information will be displayed when you move the cursor into an area covered by the new chart or, if it is already in the area, change the range scale.

If an *hsb²* series repeater display is connected, the chart can also be accessed by the repeater display. To see the chart you may need to zoom or pan, to redraw the chart area to the screen.

The boundary of each chart digitized in the current card is defined by a box or rectangle. (You can switch off the chart boundaries display if you wish, as part of the chartplotter set up described in *Section 7.7*.)

► To zoom in:

1. Use the trackpad to move the cursor inside one of the chart boxes, and press the lower part of the **RANGE** key.



That area is expanded, with the cursor at the centre, so that you can see more detail. Note that the smaller the chart box is on the screen, the further you can zoom in and the greater the amount of detail that is available.

If you have switched on **Plotter Mode** (see *Section 7.7*), you can zoom in further than the most detailed chart; all chart functions remain available.

Displaying Object Information

Chart cards include a number of displayed objects for which information is available, such as lights and buoys. If your chart includes port and tide data, this can be displayed along with information for the nearest port facility (for a selected position). Chart source data is also available. You use the context-sensitive cursor to identify the object and display detailed information.

► To obtain the chart object, port or tide information:

1. Move the cursor over the symbol for which you require the information. An Object data box such as the following is displayed at the lower left corner of the screen:

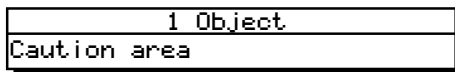

2. To view further details, press **ENTER**. The details available are listed on-screen in an object information pop-up. Use the trackpad to move the selection bar over the required item then press **ENTER** to display the full details.
3. Press **CLEAR** twice to remove the pop-up from the screen and return to the default display.

Chart Source Data

The chart card contains additional background data for most chart objects, icons, lines, open sea areas etc. Some of these items automatically provide an information data box, as described above. For other chart objects, such as bridges and territorial lines, you need to press **ENTER** to display the object information pop-up.

- To obtain chart source data, move the cursor so that is not over a symbol, then press **ENTER**. An object information pop-up is displayed, providing source information for the selected land or depth area.

Port Area

At large chart scales **port area** information is indicated by the symbol . An object information pop-up provides the name of the marina or port and a list of the facilities available.

Where available, details for each facility can be displayed. This information includes items such as accommodation, slip sizes, fueling, sanitation, electrical or other maintenance services provided, VHF channels monitored, and other safety and navigation information.

In some areas the chart shows symbols for individual facilities. The facilities and their associated symbols are illustrated in *Figure 5-2*.

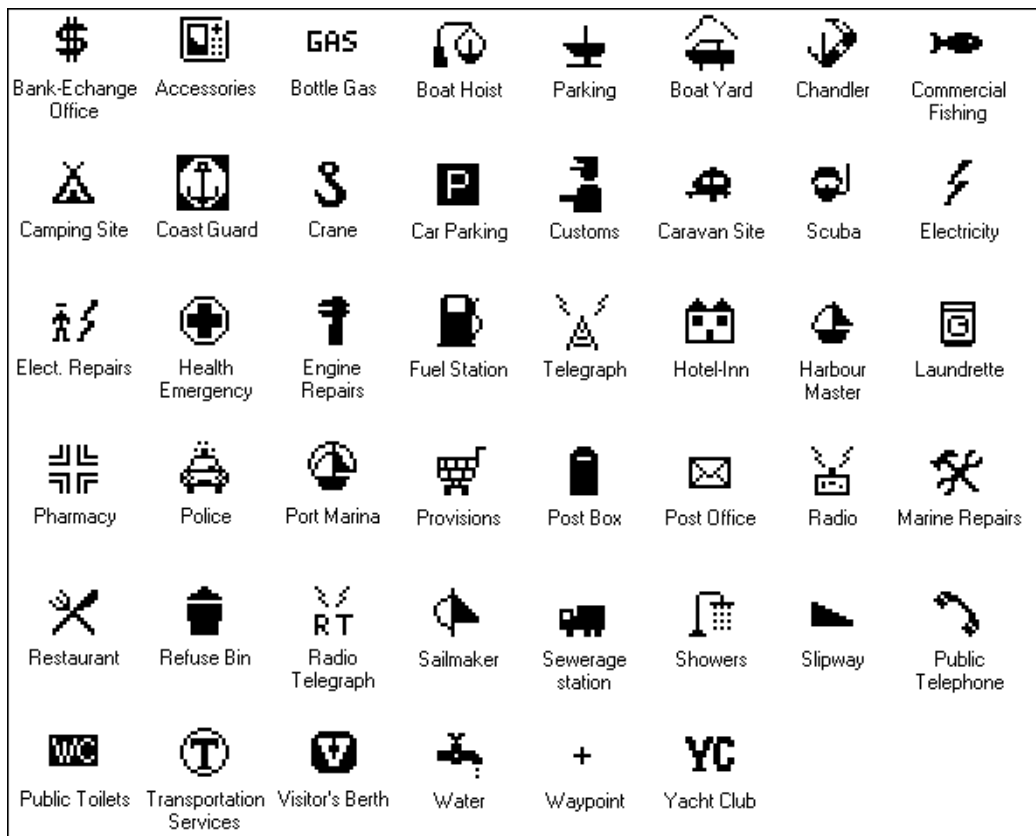



Figure 5-2: Port Symbols

Tide Data

The symbol  indicates **tide height** data is available for that position on the chart. When you select the tide height option, a graph of predictions for maximum and minimum tide heights is displayed, data for sunrise and sunset is also provided as illustrated *Figure 5-3*.

Note: *The predictions available are sufficiently accurate under moderate weather conditions, for the coastal areas served by the reference station, to be used for navigation planning. However, certain weather fronts and storms can alter tidal patterns and influence predicted times and heights.*

The cursor, represented by a dotted vertical line on the graph, is used to select a time for which the tide height is displayed.

You can use the soft keys and trackpad to change the date for which tide information is shown.

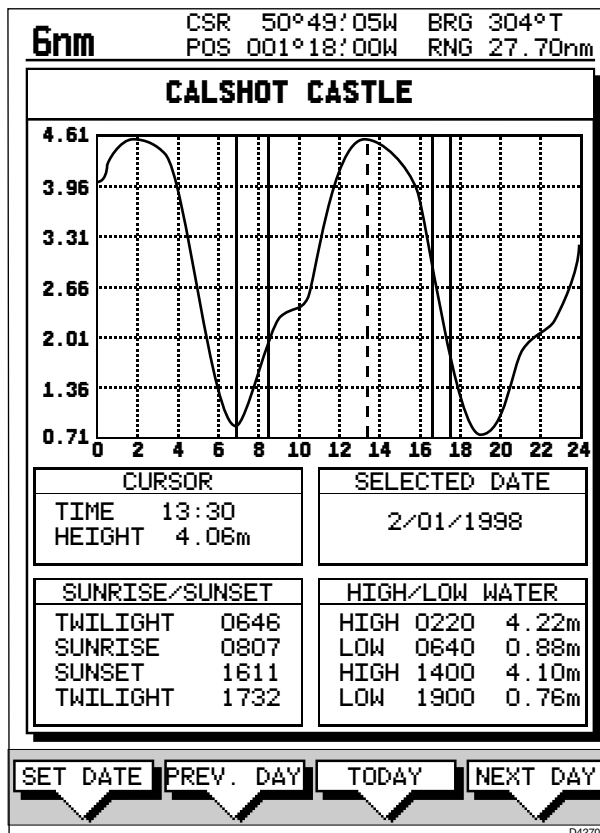

Figure 5-3: Tide Data

- To select a time, use the trackpad to move the cursor to the required time.
- To change the day press PREV. DAY, DAY or TODAY, as required. Alternatively, press SET DATE; to change date, use the trackpad to move the cursor left/right to

select the character and up/down to increase/decrease the value.
 The graph and tide data will be updated accordingly.

Nearest

- To obtain the information for the nearest port facility:
 1. Move the cursor to the required position – this can be anywhere on the chart and may be over an object – then press **ENTER** to display the object information pop-up.
 2. Press the NEAREST soft key. The port facility symbols are displayed.
 3. Use the trackpad to highlight the required facility, then press **ENTER**.
 4. The nearest ports providing that facility are listed with distance and bearing to the port.
 If you highlight a port name then press **ENTER**, details for that facility are displayed. Typical port data is shown in *Figure 5-4*.
 Press **CLEAR** to return to the port list.
 Press **CLEAR** to return to the facility symbols.
 5. Press **CLEAR** to return to the default display.



Figure 5-4: Nearest Port - Typical Data

Displaying Object Information

5.3 Working with Waypoints

Introduction

The *hsb²* series Chartplotter enables you to place up to 998 waypoints (in addition, waypoint number 999 is used for MOB operation): a waypoint is a position entered on a chart as a reference, or as a place to go to. All waypoints *placed on the chartplotter* are stored in a waypoint database list which includes symbol, position, bearing, range and additional data. All waypoints in the database are displayed on the screen, unless you set waypoint display off in the Chart Set Up menu, as described in *Chapter 7*. You can select a waypoint, either on-screen or from the list, for editing.

A waypoint can be placed at the cursor position, or at the vessel's current position (this is sometimes known as an event mark); a waypoint at the vessel position includes additional information (if available) on the depth and temperature when it was placed. Alternatively, you can manually enter Waypoints as either Lat/Long coordinates or Loran TDs which are automatically converted into Lat/Long coordinates. All waypoints can be included in a route. You can place waypoints, using simulator mode, before you install the chartplotter on your vessel.

Note: *Radar marks may also be displayed on the screen if your chartplotter is a combined radar/chartplotter or is part of an integrated system; these are screen annotations - you cannot GOTO marks, nor include them in routes.*

When you place a new waypoint, it is displayed using the default symbol of a cross (unless you have changed the symbol in Chart Set Up). The waypoint is added to the waypoint list and tagged with the next available number. You can use the edit functions to change the symbol and name. When the cursor is positioned over a waypoint, the waypoint bearing and range are displayed.

Waypoints in the current route are available on other SeaTalk instruments that support current route transfer, for example, another *hsb²* series Chartplotter or ST80 Masterview. You can transfer waypoints between the chartplotter and other NMEA or SeaTalk instruments using the Waypoint Transfer functions. You can also save waypoints to, or load them from, a user cartridge. These functions are described in *Section 5.6*.

This section explains how to perform the following tasks using the on-screen cursor and the waypoint list:

- Placing a Waypoint
- Selecting a Waypoint
- Displaying Waypoint data
- Editing a Waypoint (symbol, name & position)
- Erasing a Waypoint

- Moving a Waypoint

At the end is a section about using the ST60/80 Navigator Keypad to select, edit, and name your waypoints.

Placing a Waypoint

The scenario *Place and Goto a Waypoint* on page 2-26 provides a simple example of how to place a waypoint.

- To access the place waypoint soft keys, press **MARKS**:



- To place a waypoint at the cursor position or at the vessel position:



1. Press either the PLACE WPT AT CURSOR or the PLACE WPT AT VESSEL soft key. The waypoint is added to the waypoint list and tagged using the next available number.

The waypoint soft keys are displayed until you move the cursor away from the waypoint or press **CLEAR**.



You can use the EDIT WAYPOINT soft key to name the waypoint as described in Editing Waypoints below.

2. Press **CLEAR** or **ENTER** to remove the place waypoint soft keys.

- To place a waypoint as latitude/longitude using the Waypoint List:



1. Press **MARKS**, followed by the WAYPOINT LIST soft key. The Waypoint List and associated soft keys are displayed.
2. Press the MAKE NEW WAYPOINT soft key followed by the LAT/LONG soft key; the WPT POSITION (LAT/LONG) screen is displayed, with it's associated soft keys. The waypoint is placed at the current vessel position, or if not available, the cursor position.

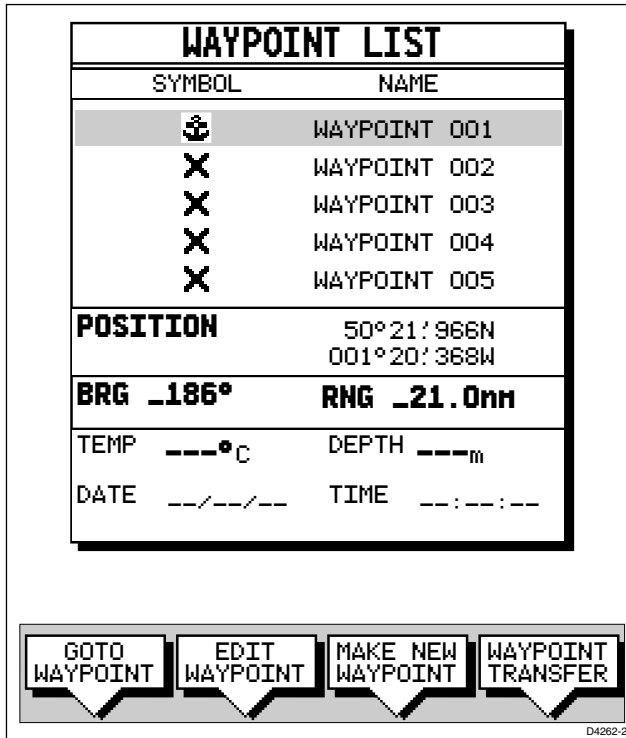

3. You can use the soft keys to edit the waypoint position as described in *Editing the Waypoint Details* on page 5-13.

It is added to the Waypoint List and named with the next available number.

To return to the default soft key display, press **ENTER** or **CLEAR** twice.

➤ To place a waypoint as Loran TDs using the Waypoint List:

1. Press **MARK**, followed by the **WAYPOINT LIST** soft key; the Waypoint List and associated soft keys are displayed.
2. Press the **MAKE NEW WAYPOINT**, the waypoint is placed at the current vessel position, or if not available, the cursor position. To change the position press the **LORAN TDs** soft key; the **WPT POSITION (LORAN TDs)** screen is displayed, with its associated soft key.

Note: You can enter waypoints as Loran TDs which are converted to Lat/Long coordinates. However, although the waypoint is shown in both Lat/Long and Loran TDs in the Waypoint List, you can subsequently only edit the position as Lat/Long coordinates. TD entries in the Waypoint List are shown only for those waypoints which were entered as TDs.

WPT POSITION (LORAN TDs)	
CHAIN	6731 - NELS Lessay
SLAVES	Y - Z (24 -39)
TD 1	29138.0
TD 2	44713.8
ASF 1	+0.0
ASF 2	+0.0



D5591-1

3. Edit the Loran parameters as required, using:
 - i. The CHAIN soft key, which enables selection of both the Chain and it's Slave:

WPT POSITION (LORAN TDs)	
CHAIN	6731 - NELS Lessay
SLAVES	Y - Z (24 -39)
TD 1	29138.0
TD 2	44713.8
ASF 1	+0.0
ASF 2	+0.0



D5592-1

- ii. The ASF1/ASF2 soft key, which presents two soft keys for editing ASF 1 and ASF 2 parameters independently:



D5593-1

- iii. The SET TD 1 and SET TD 2 soft keys, which enable editing of each TD's parameters independently.

Note: Except for the CHAIN setting, parameters are edited using the trackpad as described in *Editing the Waypoint Details* on page 5-13.

4. When editing is complete, press the **ENTER** key to save the waypoint or **CLEAR** to cancel the operation; the display returns to the New Waypoint screen.

Press the **ENTER** or **CLEAR** to return to the Waypoint List.

Selecting a Waypoint

Positioning the cursor over a waypoint selects that waypoint and accesses the waypoint soft keys. These keys enable you to GOTO (described in *Section 5.5*), EDIT (symbol, name, position), ERASE or MOVE the waypoint.

Selecting a waypoint from the List allows you to GOTO and EDIT (symbol, name, position, erase) the waypoint. The Waypoint List also provides options to make a new waypoint and transfer waypoints.

- To select a waypoint using the cursor:



1. Move the cursor over the waypoint, until the letters WPT are displayed.

The Waypoint Data box (see *Waypoint Data Display* on page 5-12) and the following soft keys are displayed:

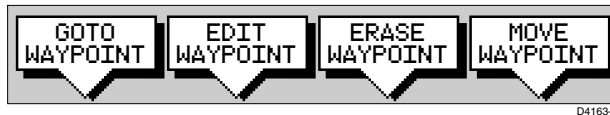

The selected waypoint can be edited via these soft keys.

- To select a waypoint using the Waypoint List:



1. Press **MARKS**, followed by the WAYPOINT LIST soft key.

The Waypoint List and associated soft keys are displayed.

The list details all waypoints in alpha-numeric order. The selected waypoint is indicated by the selection bar; its position, bearing and range are provided.

2. Use the trackpad to move the selection bar up and down the list to highlight the required waypoint.

The selected waypoint can be edited via the soft keys displayed.

Waypoint Data Display

Waypoint data can be viewed in two ways: you can use the context-sensitive cursor to select the waypoint and thus display the waypoint data box, or you can view waypoint details on the waypoint list.

Note: To permanently display the target waypoint data box, select it in the System Set Up menu (see *Section 7.3*) and use the SCREEN soft key to switch data boxes on.

- To display the waypoint data box, move the cursor over the waypoint.

The waypoint data box is displayed, this indicates waypoint number/name, bearing and range (or latitude and longitude if selected in system set up).

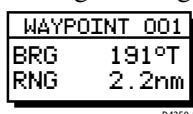

While the cursor is over the waypoint, the waypoint soft keys are displayed.

- To remove the waypoint data box and soft keys either:
Move the cursor away from the waypoint, or press **CLEAR**.
- To display the waypoint details from the waypoint list:



Select the waypoint in the list as described above.

The details for the selected waypoint are displayed in the lower half of the window. Temperature, depth, date and time are included (if available) for waypoints placed at the vessel position.

To remove the Waypoint List and return to the default soft key display, press **CLEAR** twice.

Editing the Waypoint Details

You can change the name, symbol and position of any waypoint.

- To edit a waypoint:
 1. Select the waypoint, using the cursor or the waypoint list, as previously described. The waypoint soft keys are displayed.
 2. Press the EDIT WAYPOINT soft key. The Edit Waypoint soft keys are displayed:

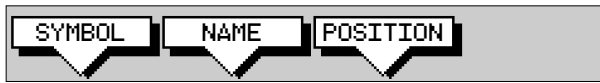

D4166-1

3. To edit the symbol, press the SYMBOL soft key.

Use the soft keys, shown in the following illustration, to highlight the required symbol, then press **ENTER** to confirm the selection.

Press **ENTER** or **CLEAR** to return to the default soft keys.



D4178-1

4. To edit the waypoint name, press the NAME soft key.

The NAME WAYPOINT window is displayed.

Use the trackpad to enter or edit the name:

Use the left or right side of the trackpad to move the cursor to the character you wish to change.

Use the top or bottom of the trackpad to scroll through the characters.

When you have finished editing the name, to remove the window, press **ENTER** to save the name or **CLEAR** to cancel the operation. The waypoint name replaces the waypoint number.

Press **ENTER** or **CLEAR** to return to the default soft keys.



- To edit the waypoint position, press the EDIT WAYPOINT soft key, followed by POSITION. The Waypoint Position pop-up is displayed.

Use the soft keys to select LAT, LON, BRG or RNG.

Use the trackpad to edit the value:

Use the left or right side of the trackpad to move the cursor to the character you wish to change.

Use the top or bottom of the trackpad to scroll through the characters.

Adjust each parameter until the waypoint position is correct.

When you have finished editing the position, press **ENTER** to save the position or **CLEAR** to cancel the operation. Press **ENTER** or **CLEAR** again, the Waypoint Position window is removed from the screen and the default soft keys are displayed.

Erasing a Waypoint

You cannot erase the target waypoint or waypoints that are used in routes. However, you can remove a waypoint from the current route - see *Editing a Route* on page 5-27.

If you try to erase a waypoint that is used in a saved route you are warned "WAYPOINT IS USED IN A ROUTE & CANNOT BE DELETED"

- To delete a waypoint using the cursor:



- Move the cursor over the waypoint, until the letters WPT are displayed. The waypoint soft keys are displayed.
- Press the ERASE WAYPOINT soft key. The waypoint is removed from the screen and the Waypoint List is updated.

Note: *If you have stopped a GOTO (see Stop Follow or Stop Goto on page 5-34), the target waypoint remains displayed as a target; you need to use the CLEAR GOTO soft key before you can erase the waypoint using the cursor.*

- To delete a waypoint using the waypoint list:



- Select the waypoint from the waypoint list as previously described. The waypoint list soft keys are displayed.
- Press the EDIT WAYPOINT soft key, followed by ERASE WAYPOINT. The waypoint is removed from the screen and the waypoint list is updated.

Moving a Waypoint

You can move any waypoint except the target waypoint (the waypoint you are following). You can use the Waypoint soft keys and cursor to move the selected waypoint, or you can edit the waypoint position.

CAUTION:

Take care when editing waypoints as it is possible to move waypoints that are used in routes stored in the Route Database. In such instances, the stored route will include the waypoint in its new position.

- To move a waypoint using the cursor:

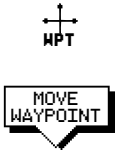

1. Move the cursor over the waypoint, until the letters WPT are displayed. The waypoint soft keys are displayed.
2. Press MOVE WAYPOINT, the cursor changes to a four-headed arrow.
3. Move the cursor to the required waypoint position.
Press **ENTER** to set the position and return to normal cursor control.
Press **CLEAR** to cancel the operation.

- To move a waypoint using the Waypoint Edit functions:

1. Select the waypoint using either the cursor or the waypoint list as described above. The waypoint soft keys are displayed.
2. To edit the waypoint position proceed as previously described in *Editing the Waypoint Details* on page 5-13.

Using the ST60 or ST80 Navigator Keypad

If you have an ST60 or ST80 Navigator Keypad connected on SeaTalk it can be used to name or edit your waypoints, tracks, or routes on any display in the system. The keypad can also be used to select entries in the Waypoint List. The Navigator provides 10 dedicated alphanumeric keys, a multidirectional cursor control pad, plus Insert and Delete keys.

Note: *When using the Navigator Keypad, you should be aware that it can control several displays simultaneously; any display in edit mode (i.e. ready for alpha-numeric data entry) will be affected by the Navigator Keypad.*

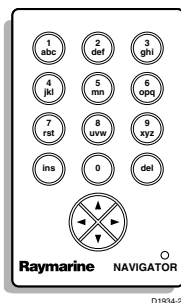

Figure 5-5: ST80 Navigator Keypad

Most of the alphanumeric keys are used to input multiple characters. Each time you press one of these keys in succession, the next character on that key is input. For example, each press of the **1** key alternately inputs A, B, C, then 1.

The Navigator's arrow keys function much like the radar/chart display's trackpad, enabling you to move the cursor position or input alpha, numeric, or special characters (. , - / ' &).

The **ins** key functions the same as the **ENTER** key on radar/chart display and **del** inserts a space during edit mode.

Selecting an Entry in the Waypoint List

The Navigator can be used to select an existing item in the Waypoint List. This can be accomplished using the arrow or alphanumeric keys.

- To select an existing item in the Waypoint List:
 1. Use the up and down arrow keys to move the selection bar up and down the list to highlight the desired entry.

or

Press the alphanumeric key that contains the first letter or number of the desired waypoint name. The selection bar moves to the entry starting with that letter or number.

If more than one entry begins with that character, the selection bar moves to the first one in the list. Each time the same key is pressed, the selection bar moves to the entry starting with the next character on the key. If no entry exists for that character, the entry starting with the nearest previous character is selected. If the numeric value of the key is input when no numeric entry exists, the selection bar moves to the first alpha entry.

For example, let's say we have four waypoints named ORION, POLARIS, QUANTUM, and 6-GUN. Pressing the **opq/6** key four successive times would select the waypoints ORION (O), POLARIS (P), QUANTUM (Q), then 6-GUN (6). However, pressing the **rst/7** key four successive times would select QUANTUM for the first three key presses because entries beginning with the associated letters do not exist and Q is the next previous beginning letter. The fourth press of the **rst/7** key would select 6-GUN because no entries begin with a 7 and 6 is the next previous beginning number.

2. Use the **ins** key like the display's **ENTER** key, to close the Waypoint List. The **del** key and left and right arrow keys do not function in select mode.

Editing Entries in the Waypoint, Route, or Track Lists

You can also use the Navigator Keypad to edit an existing item or to name a new item in the Waypoint List, Route List, or Track List. You first must enter the edit mode for the list you want to modify. Methods for editing each list are described in the respective sections of this chapter.

- ▶ To edit an item in a list using the Navigator Keypad:
 1. If necessary, use the right and left arrow keys to move the cursor to the desired character position.
 2. Press an alphanumeric key until the desired character is displayed. Each time you press one of these keys in succession, the next character on that key is input.
or
 1. Use the up and down arrow keys to scroll through the list of alpha, numeric, and special characters until the desired character is displayed (just as you would with the trackpad). Note that you must use this method to input special characters; they are not available using the alphanumeric keys.
Use the **del** key to insert a space, if required.
 2. Use the arrow keys and alphanumeric keys to input the remainder of the characters required to complete the editing.
 3. When done, press the **ins** key to enter your changes.

5.4 Working with Routes

A route is made up of a series of waypoints (maximum 50). To make a route you place a series of waypoints on the chart, or you can select waypoints from the Waypoint List. You can also save your vessel's track as you navigate, then convert the track to a route - this function is described in *Section 5.7*.

When a route is created it becomes the current route and is displayed on-screen. The current route is maintained when you power-off. Only one route can be current and is displayed (if it is in the field-of-view) as solid lines connecting waypoints. If you are following the route, the current leg is shown as a dotted line and previous legs are removed from the screen (although the waypoints remain displayed). The current route (and its waypoints) is transferred via SeaTalk to a repeater chart display and other instruments. You can also use the Waypoint Transfer functions to transfer the route database to a repeater display.

Once you have created a route you can use the GOTO soft keys to follow the route. In addition, the GOTO default soft key provides various options as described in *Section 5.5*.

Up to 20 routes can be saved in the route database. You can then select a route from the database list as the current route.

The current route can be edited by adding and moving waypoints. The current route is always placed in the database list as route number 0, so you can edit the current route without affecting the original route in the database. Once a route has been saved, options are also provided to name a route, erase a route and to display route details.

You can use the route information to review your passage plan by adjusting the planned Speed Over Ground (SOG).

Note:

1. The route database is stored locally, in the display unit on which it was created. Although the current route is automatically transferred, you need to use the WAYPOINT TRANSFER function, described in Section 5.6, to transfer the complete route database to a repeater display connected via hsb². Alternatively you can save routes, and load them from a user cartridge.

2. It is possible for the current route to be overwritten by a route from another unit on an integrated system, so it is advisable to save all routes.

This section explains how to perform the following tasks:

- Creating a new route.
- Saving the current route in the database list.
- Clearing the current route.

- Retrieving a route from the database list as the current route.
 - Displaying route information, including the route leg data and waypoint details. Use the waypoint details to review your passage plans for different speeds.
 - Using the database list to erase and name existing routes.
 - Editing a route by adding, removing and moving waypoints.
- To access the route soft keys, press the default soft key ROUTE:



Creating a New Route

Note: *If there is a current route, it is cleared when you select MAKE ROUTE. If you are following the current route you are prompted to STOP FOLLOW. Press the YES soft key to continue, or NO to abandon route creation. If the route has not been saved you are prompted to save it.*

The chart scenario *Make and Follow a Route* on page 2-28 provides a simple example of how to create a route.

There are two methods to create routes, whilst creating a route you can switch between these methods:

- Placing new waypoints on the chart.
- Selecting existing waypoints from the Waypoint List.

You can edit a route after you have finished making it, as described in *Editing a Route* on page 5-27.

- To make a new route by placing waypoints:

Note: *You can pan the chart and change the scale while placing waypoints.*

1. If necessary, move the cursor to the area in which you wish to make the route, and select a suitable chart scale.
2. Press the ROUTE soft key, then press the MAKE ROUTE soft key. The make route soft keys are displayed:

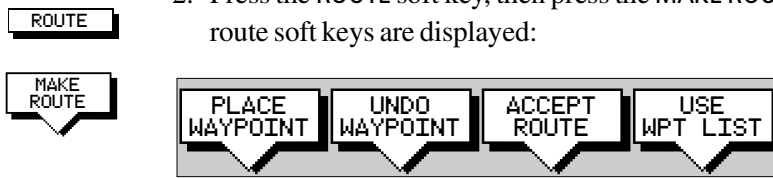

3. Move the cursor to the position on the chart where you want your first waypoint to be. Press the PLACE WAYPOINT soft key.



Note: You can position the cursor on an existing waypoint – the cursor text WPT indicates you are re-using the waypoint rather than placing a new one. This waypoint is included in the route when you press PLACE WAYPOINT.

The waypoint appears on the screen at the cursor position. The number displayed alongside the waypoint identifies its position in the route. The new waypoint is temporarily added to the waypoint list with the first available waypoint number. The waypoints in the current route are re-numbered to identify the new positions.

Note: If you Clear the route before it is Saved, the waypoint is removed.

4. Move the cursor to the next waypoint position. A dotted line connects the cursor to the last placed waypoint.

5. Press PLACE WAYPOINT again. The waypoint is placed and the dotted line changes to a solid line.

If you placed the waypoint incorrectly, you can delete the last-placed waypoint by pressing the UNDO WAYPOINT soft key.

6. Repeat steps 4 and 5 until you have placed all your waypoints. You can have up to 50 waypoints in a route.

7. When you have entered all your waypoints, either:

Press the ACCEPT ROUTE soft key (or **ENTER**) to complete the route. Your route is displayed on the screen, and is the current route, but it is not active.

The first waypoint of a new route is outlined with a square, indicating that it will be the target waypoint when the route is activated. If selected, the waypoint data box is displayed for the target waypoint.



You can save the route as described below.

Note: The completed route is stored in the display unit, and will be re-displayed if you turn the unit off and on again. However, on an integrated system it is possible for a current route from another unit to overwrite this route; it is therefore recommended that you Save the route as described below.

► To make a new route using the Waypoint List:

1. Press the ROUTE soft key; the route soft keys are displayed.

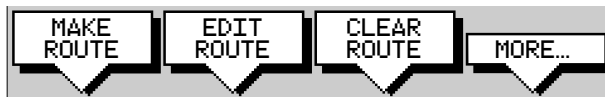

D4167-1A

2. Press the MAKE ROUTE soft key; the make route soft keys are displayed.



D5575-1

- Press the USE WPT LIST soft key; the MAKE ROUTE screen is displayed with its associated soft keys.

MAKE ROUTE	
WAYPOINTS	NEW ROUTE
COWES	01 HARBOUR
GURNARD LEDGE	02 MAIN CHANNEL
MAIN CHANNEL	03 COWES
NEEDLES FAIRWAY	04 LYMINGTON
PORT SOLENT	
50°50'00N 001°06'00W	50°52'23N 001°02'39W
348°_m 2.30_{nm}	300°_m 1.00_{nm}

INSERT WAYPOINT	REMOVE WAYPOINT	ACCEPT ROUTE	USE CURSOR
-----------------	-----------------	--------------	------------

D5574-1

The available Waypoints are listed in the left hand column (alphanumeric); the right hand column lists the waypoints in the New Route, the number indicates its order in the route. The lower part of the table shows position, bearing and range of the highlighted waypoint.

You use the trackpad left/right to move control between the two columns (the highlighted title indicates the selected column) and the trackpad up/down to scroll through the lists.

- Select a waypoint from the Waypoint List then go to the New Route column and select a position in the list.
- Press the INSERT WAYPOINT soft key to place the waypoint *below* the selected position in the Route. You can have up to 50 waypoints in a route.
- To remove a waypoint from the New Route column, highlight the waypoint and press the REMOVE WAYPOINT soft key.

Notes: (1) A waypoint cannot be used more than once in a route; those already used are displayed in a lighter shade of gray.

Notes: (2) The INSERT WAYPOINT or REMOVE WAYPOINT action adds/removes the highlighted waypoint to/from the Route column, regardless of which column is selected.

- When all waypoints have been entered, press the ACCEPT ROUTE soft key (or **ENTER**) to complete the route.

Note: The completed route is stored in the display unit and will be re-displayed if you turn the unit off then on again. However, on an integrated system it is possible for a current route from another unit to overwrite this route; it is therefore recommended that you save the route, as described in Saving the Current Route on page 5-22.

Saving the Current Route

You can save up to 20 named routes in the route database list. These routes can then be re-displayed and followed at a later date. When you save the route, all new waypoints are saved in the Waypoint List.

Note: *If the current route has not been saved, when you attempt an operation that affects this route, e.g. CLEAR ROUTE, you are prompted to save it.*

► To save and name the current route:

ROUTE

1. To access the SAVE ROUTE soft key, press the ROUTE soft key, followed by MORE.

SAVE ROUTE

2. Press the SAVE ROUTE soft key. The save route pop-up and the NAME ROUTE soft keys are displayed as illustrated in *Figure 5-6*.

3. The next available entry on the route list is highlighted.

(If required, you can use the trackpad to select another position in the list; this can be a blank slot, or an existing route that you no longer require).

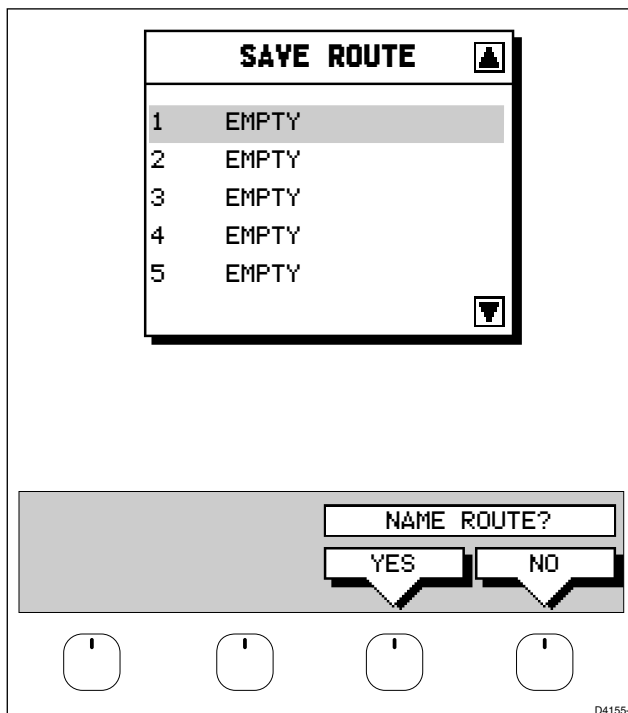

Figure 5-6: Save Route Window

4. If you do not wish to name or re-name the route, press the NO soft key to clear the list. The route is saved and is listed as Route Not Named.

If you wish to name the route press the YES soft key. Use the trackpad to move the cursor right or left to the character you wish to edit. Then use the top or bottom of the trackpad to increase or decrease the letter or number.

You can use a Navigator Keypad (see *Using the ST60 or ST80 Navigator Keypad on page 5-15*) to name the route.

- 5. Press **ENTER** to finish and clear the Name List, or press **CLEAR** to cancel the operation. To return to the default soft key display, press **ENTER** again.

Clearing the Current Route

You can clear the current route from the screen. When you select CLEAR ROUTE if the current route has not been saved, you have the option of saving it and, if you are following the current route, you have the option to stop.

► To clear the current route:

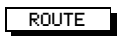

1. Press the ROUTE default soft key or place the cursor over a route leg until the text RTE is displayed.
Press the CLEAR ROUTE soft key.
2. If you are following the current route the STOP FOLLOW soft keys are displayed.
To cancel the CLEAR operation press NO.
To stop following and clear the route press YES.
3. If the route has not been saved the SAVE ROUTE soft keys are displayed.
To clear the route, without saving it in the route database, press NO.
To save the route in the database, press YES. The Name route soft keys are displayed and you should continue as described in the previous section, *Saving the Current Route on page 5-22*.

The current route is cleared from the screen and the default soft keys are displayed. You can now use the ROUTE soft keys to make a route, or to show another route from the database.

Retrieve a Route From the Database

You can select a route as the current route from the database list. The list is accessed from the second set of ROUTE soft keys.

► To select a route as the current route:



1. Press the ROUTE soft key, followed by MORE, then press ROUTE LIST. The route list is displayed as illustrated in *Figure 5-7*. The selection bar indicates the selected route.
2. Use the trackpad to select the required route then press the SHOW ROUTE soft key. The chart is re-drawn at a scale suitable to display the whole route.

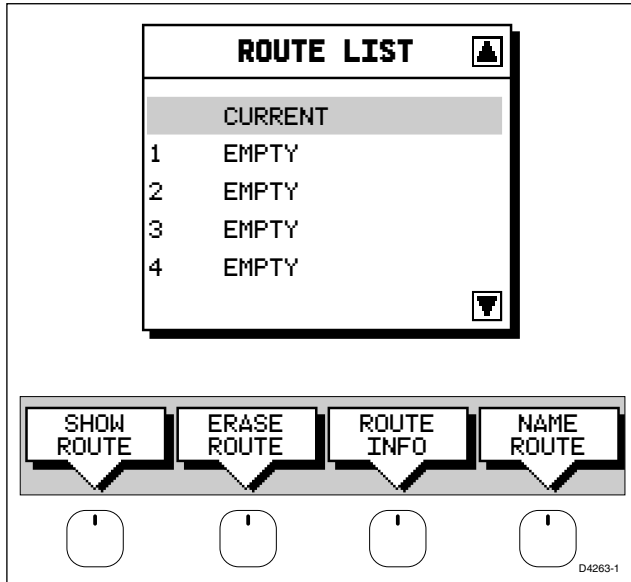

Figure 5-7: Route List Window

Displaying Route Information

You can display the following information that relates to your route:

- Route leg or waypoint information, using the context-sensitive cursor.
- Details of waypoints in the route, using the soft keys. You can use this information to review your passage plan.

Route Leg and Waypoint Information

- To display information about a route leg, move the cursor over the leg until the letters RTE are displayed. A Route Leg data box such as the following is displayed.

RTE

ROUTE NO.
ROUTE NAME
LEG 02 - 03
0°T 5.5nm

D4259-2

To remove the data box, move the cursor away from the route or press **CLEAR**.

- To display information about a route waypoint, move the cursor over the waypoint until the letters WPT are displayed. The waypoint data box is displayed, this box includes the route and waypoint number.

WPT

To remove the data box, move the cursor away from the route or press **CLEAR**.

Using Route Information to Review Your Passage Plan

You can view data for all the waypoints in the current route, or any saved route.

You select the route from the database list and the information is displayed in a Route Information pop-up; the following details are provided for each waypoint:

- Position
- Bearing (from previous waypoint)
- Length of leg (from previous waypoint)
- Total Length
- Time (ETA or Elapsed)

Soft keys are provided to toggle the time between ETA or elapsed and to change the Speed Over Ground (SOG) value; the ETA for each waypoint is calculated using the selected SOG, so you can change the SOG to determine its effect on your ETA.

The chart scenario *Review Your Passage Plan* on page 2-30 provides a simple example of how to use the route information.

- To display information about any route in the database:

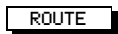

1. Press the ROUTE soft key, followed by MORE, then press ROUTE LIST. The route list is displayed. The selection bar indicates the selected route.
2. Use the trackpad to select the required route, then press the ROUTE INFO soft key.



The Route Information pop-up is displayed. As illustrated in *Figure 5-8*, this lists the waypoints in the route and details bearing, length of each leg, total distance, and either the estimated time of arrival (ETA) or the elapsed time.

The soft keys allow you to toggle between ETA or total (elapsed) time, and to change the Speed Over Ground (SOG) value used in the time calculations. The current selections are highlighted.

- To change the SOG used for ETA calculations:

1. Press one of the PLANNED SOG keys to switch from actual to planned SOG.
2. Press the up or down PLANNED SOG keys to change the planned SOG value. The Time values in the Route Information list are updated.
3. Press the ACTUAL SOG key to use the actual SOG value rather than a planned one.

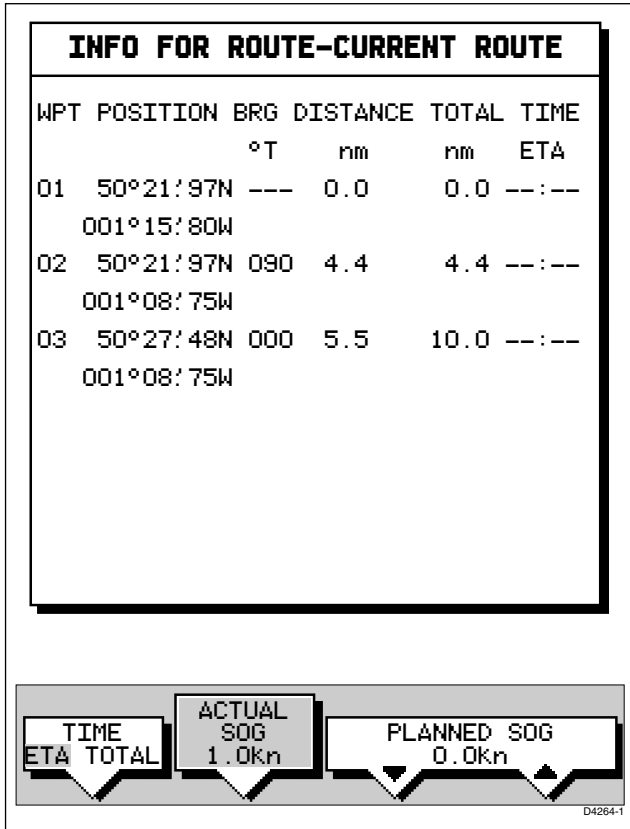

Figure 5-8: Route Information Window

4. Press **ENTER** to remove the Route Information window, then **ENTER** or **CLEAR** to return to the route soft keys.
5. To return to the default soft key display, press **ENTER**.

Using the Route List to Erase and Name a Route

You can delete a route and you can re-name a route by selecting the route on the route list.

- To select a route to delete or re-name:



1. Press the **ROUTE** soft key, followed by **MORE**, then press **ROUTE LIST**. The route list is displayed. The selection bar indicates the selected route. Press the appropriate soft key – **ERASE ROUTE** or **NAME ROUTE**.



2. If you **ERASE** a route you are prompted to confirm. Press **NO** to cancel the operation, then **ENTER** or **CLEAR** if you wish to remove the route list. Press **YES** to erase the route from the list, then **ENTER** or **CLEAR** to remove the route list.



3. If you **NAME** a route, use the trackpad to move the cursor right or left to the character you wish to edit. Then use the top or bottom of the trackpad to increase or decrease the letter or number.
4. Press **ENTER** to clear the Name List, or **CLEAR** to cancel the name then to return to the default soft key display, press **ENTER** again.

Editing a Route

Once you have created a route, you can edit it using the Waypoint List as described in *Creating a New Route* on page 5-19, or using the context-sensitive cursor to:

- Insert a Waypoint into the route
- Add waypoints at the end of the route
- Remove a Waypoint
- Reverse a Route
- Move a Waypoint as described in *Moving a Waypoint* on page 5-14.

Any changes you make to the route, except move a waypoint, affect only the current route. The current route is always held in position 0 in the database, so you need to Save the route if you want to keep the changes.

Inserting a Waypoint into a Route

You can use the context-sensitive cursor to insert one or more waypoints in the current route. However, if the route is being followed you cannot insert a waypoint into the current leg.

- To insert a new waypoint in the current route:



1. Move the cursor over the route leg into which you wish to insert a waypoint. The letters RTE and the route leg data box are displayed. The Route soft keys are displayed.
2. Press **ENTER**. The cursor changes to a four-way arrow, controlling a new waypoint. The waypoint is connected to the existing waypoints on either side with a dashed line.
3. Move the new waypoint to the required position, and press **ENTER** to drop it and return to normal cursor operation, or **CLEAR** to abandon the operation.

The new waypoint is temporarily added to the waypoint list and named with the first available waypoint number. The waypoints in the current route are re-numbered to identify the new positions.

Note: *If you Clear the route before it is Saved, the new waypoint is removed.*

Adding Waypoints at the End of the Route

- To add waypoints at the end of the route:



1. Press the ROUTE soft key, followed by the EDIT ROUTE soft key.

The Make Route soft keys are displayed and the cursor is connected to the last-placed waypoint with a dotted line. You can add further waypoints to the route in the same way as for a new route.



2. Either:



- i. Move the cursor to the required location, and press PLACE WAYPOINT soft key.

If you place the waypoint in the wrong position, press the UNDO WAYPOINT soft key.



Or

- ii. Press USE WPT LIST, the MAKE ROUTE pop-up is displayed.

Select a waypoint from the Waypoint List then press the INSERT WAYPOINT soft key to place the waypoint at the end of the Route.

3. Place as many waypoints as required, and press the ACCEPT ROUTE soft key, the default soft keys are displayed.



Note: You can UNDO waypoints in the original route, not just the new ones.

Removing a Waypoint from the Route

- To remove a waypoint from the current route:



1. Move the cursor over the required waypoint until the letters WPT are displayed. The waypoint soft keys are displayed.

2. Press the REMOVE WAYPOINT soft key. The waypoint is removed from the route and the route is re-numbered.



Alternatively, you can remove the last waypoint from a route by pressing the UNDO WAYPOINT soft key, as described above in *Adding Waypoints at the End of the Route* on page 5-28.

If the route has *not* been saved and the waypoint was placed as part of the route, the waypoint is erased.

If the route has been saved, or the waypoint existed before you created the route, the waypoint remains on the screen.

Reversing the Route

► To reverse the route, so you can Follow the route back:

A rectangular button with the word "ROUTE" in capital letters.

1. Either press the **ROUTE** soft key followed by **MORE**, or move the cursor over the required waypoint until the letters **RTE** are displayed.

The route soft keys are displayed.

A rectangular button with the words "REVERSE" and "ROUTE" stacked vertically in capital letters.

2. Press the **REVERSE ROUTE** soft key. The current route is reversed on the screen.

5.5 Following Routes and Going to Points

The default soft key GOTO accesses the functions to FOLLOW a route and GOTO a waypoint or cursor. When you select the target destination, the chartplotter calculates bearing, distance and cross track error; this information is passed to a helmsman or autopilot. You can also restart the cross track error (XTE) from the actual vessel position to set XTE to zero at that point.

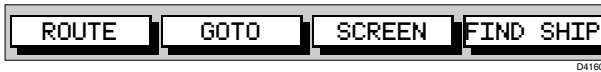

D4160-1

When the chartplotter is following a route, the target destination is indicated by a square around the waypoint (or cursor marker) and a dotted line shows the intended track, from your start point or previous waypoint, to the target waypoint.

This section describes the following:

- Follow a route either forwards, or in reverse order.
- Target Point Arrival
- Other follow route options, including joining at a selected waypoint, advancing waypoints, and restarting XTE.
- Go to an individual point, either an existing waypoint or the cursor.
- Stop and Restart Follow/Goto.

An alarm is triggered when you approach a waypoint, this section describes what happens when you arrive at waypoints. *Chapter 6* describes how to set the alarm.

The chartplotter can also display the vessel's actual track and the track can be recorded for later display. The Track function is described in the *Section 5.7*.

- To access the Goto/Follow soft keys, press the default soft key GOTO (the soft keys differ if a follow or goto is already in progress):

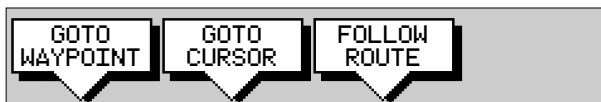
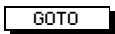

D4171-1

Follow a Route

Note: *The current route may have been created on this display, or created on another unit and received on this display via SeaTalk.*

If a route has been reversed or if a route on screen was being followed but stopped before completion, the target waypoint – outlined by a square box – may be different to when the route was created.

You should always check the target waypoint before initiating a follow route.

► To follow the current route:



1. Press the GOTO default soft key. The Goto/Follow soft keys are displayed.
2. Press the FOLLOW ROUTE soft key.



Alternatively, to follow a route:



1. Place the cursor over a route leg until the letters RTE and the route soft keys are displayed then press FOLLOW ROUTE.



Your vessel's current position becomes the origin, and the target waypoint in the current route becomes the active target.

The soft keys change as follows:

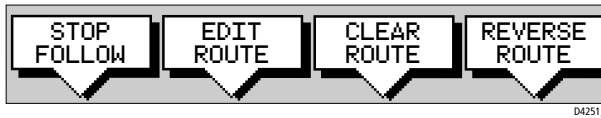

These options are described in the following sections.

► To follow the current route in reverse:

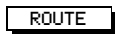

1. Press the ROUTE default soft key, followed by MORE. The route soft keys are displayed.



2. Press the REVERSE ROUTE soft key. The current route is reversed on the screen. Press **ENTER** or **CLEAR**.

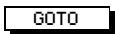

3. Press the GOTO default soft key. The Goto/Follow soft keys are displayed.



4. Press the FOLLOW ROUTE soft key.

The soft keys change as follows:



These options are described in the following sections.

Alternatively:



1. Place the cursor over the route leg until the letters RTE and the route soft keys are displayed. Press REVERSE ROUTE then FOLLOW ROUTE.



Your vessel's current position becomes the origin, and the target waypoint in the current route becomes the active target.



Target Point Arrival

The arrival alarm is used to alert you when the vessel is approaching the target point. The arrival alarm is defined as a circle (not visible on the screen) around the target. You can specify radius of the arrival alarm (see *Section 6.3*).

The alarm is triggered when either of the following conditions is met:

- The distance to the target point is less than that specified for the arrival alarm.
 - Your vessel reaches the closest point of approach to the target (defined by a line passing through the waypoint and perpendicular to the route leg).
- To cancel the arrival alarm and go towards the next waypoint in the route,
- either press any key
or wait for 10 seconds.

The target becomes the origin, the next waypoint becomes the target point, and the two are connected by a dotted line indicating the current leg. Any previous route leg is removed from the screen, but waypoints remain.

Note: *When following a route using a SeaTalk autopilot, the autopilot will not turn to the new waypoint until it is accepted at the autopilot control unit.*

Other Follow Route Options

You can use the soft keys to follow a route from a selected waypoint (join a route), or if already following, you can advance to the next waypoint. You can also restart the cross track error, setting the current vessel position as the new origin.

In addition, you can move a selected waypoint as described in *Section 5.3*, or remove a waypoint from the route as described in *Section 5.4*.

Joining a Route

- To start tracking the current route at a selected waypoint:

1. Move the cursor over the required waypoint until the letters WPT and the waypoint soft keys are displayed.

2. Press the FOLLOW FROM HERE soft key.

Your vessel follows the route, using the selected waypoint as the target point.

3. To return to the default display, move the cursor away from the waypoint or press **CLEAR** or **ENTER**.



Advancing to a Waypoint

- Once you are following a route, you can advance to the next waypoint, even if you have not reached the current target waypoint:



1. If necessary, press the GOTO default soft key to display the Goto/Follow soft keys.



2. Press the WAYPOINT ADVANCE soft key. The current leg of the route is abandoned and the next waypoint becomes the target. The display is updated to show the new route leg.

Restart Cross Track Error (XTE)

While you are following a route, or going to a target point, you can restart the XTE. This sets the XTE to zero and moves the origin to the actual vessel position.

Restarting XTE is useful if you find yourself off track and want to go straight to your target, rather than get back onto the original track.

- To restart XTE:

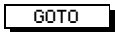

1. Press the GOTO default soft key, the Follow/Goto soft keys are displayed.



2. Press the RESTART XTE soft key. The route origin moves to the current vessel position, thus the XTE becomes zero.

Going To an Individual Target Point

Rather than following a route, you can go directly to a selected target point, this can be an existing waypoint (not in the current route), or the cursor position.

- To navigate directly to an existing waypoint:

1. Use the trackpad to position the cursor over the required waypoint until the letters WPT and the waypoint soft keys are displayed.

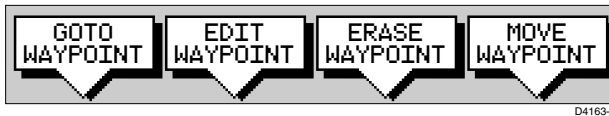

Alternatively, you can select the waypoint from the waypoint list as described in *Section 5.3*.



2. Press the GOTO WAYPOINT soft key.
Navigation to the selected waypoint begins. The soft key STOP GOTO is displayed.
3. To return to the default soft key display, move the cursor away from the waypoint or press **ENTER** or **CLEAR**.

► To navigate directly to the cursor position:



1. Use the trackpad to position the cursor as required.
2. Press the GOTO default soft key, followed by GOTO CURSOR.
If navigation is currently in progress you are warned “Already following route. Cancel route and goto cursor?”.



To cancel the GOTO CURSOR operation, press NO.
To continue with the GOTO CURSOR operation (and stop the current GOTO ROUTE), press YES.

The chartplotter places a temporary waypoint as the target and starts to navigate towards it. The waypoint is shown as a square with a circle and dot in the centre, and is connected to the vessel’s starting position with a dashed line.



The soft key STOP GOTO is displayed.

3. To return to the default soft key display, move the cursor away from the waypoint or press **ENTER** or **CLEAR**.

Stop Follow or Stop Goto

► To stop following the route or target point either:

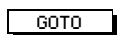

1. If necessary, press the GOTO soft key, then press the STOP GOTO/FOLLOW soft key.



Or:



1. Move the cursor over any waypoint or leg in the current route, then press the STOP GOTO/FOLLOW soft key.

The dotted line from your vessel to the target waypoint disappears.

If you stopped a GOTO WAYPOINT or CURSOR, to remove the target point from the screen, move the cursor over the target point then press the CLEAR GOTO soft key.

If you subsequently use the FOLLOW ROUTE soft key to restart navigation, the route is followed from the point at which it was stopped. This is indicated by a square around the target waypoint. If you want to follow from another waypoint you can initiate the follow then use the WAYPOINT ADVANCE or FOLLOW FROM HERE soft key to step through the route.

5.6 Transferring Waypoints and Routes

Displayed SeaTalk Waypoints

In an integrated system, when a route is made current on any SeaTalk equipment it is sent to all SeaTalk instruments, including this chartplotter; this route will override any other current route. When GOTO waypoint or GOTO cursor is in operation it is considered a route.

The current route can be edited on any instrument with route edit capability.

Note: *Transferred waypoints are not automatically saved by the chartplotter, however you can save the route locally, thus adding the waypoints to the local waypoint list.*

Managing Database Lists

There are several methods of maintaining database lists. The method you choose will depend on the links available (SeaTalk, NMEA or *hsb²*), and whether you want to transfer individual waypoints or the complete waypoint and route list:

- You can save the complete Waypoint and Route Lists to a user cartridge in the chart card slot.
- You can load new Waypoint and Route Lists from a user cartridge in the chart card slot.
- If waypoints are transmitted by other equipment on SeaTalk or NMEA, you can receive them on the chartplotter.
When RECEIVE WPTS FROM ST/NMEA is selected, any waypoints sent on SeaTalk or NMEA are transferred and appended, one-by-one, to the waypoint list; routes sent on NMEA are appended to the route list.
You can use this function to add waypoints from a PC connected via NMEA.
- You can send the waypoint **and** route lists from the chartplotter to other instruments via NMEA using the SEND WPT LIST function.
Sending the waypoint list does not affect **current** routes.
The NMEA link could be to a PC.
- You can transfer the waypoint **and** route lists from one chartplotter to another across an *hsb²* link using SEND WPT LIST ON HSB and RECIEIVE WPTS FROM HSB.

CAUTION:

The functions LOAD USER CARD, SEND WPT LIST ON HSB and RECIEIVE WPTS FROM HSB replace the existing waypoint and route lists with the transferred lists.

- To save waypoints to, or load waypoints from a user cartridge:

CAUTION:

Loading waypoints from a user cartridge overwrites any existing waypoint and route lists.



1. Insert a C-MAP User Card into the lower of the two cartridge slots.
1. Press **MARKS** followed by the LOAD/SAVE USER CARD soft key.
2. The User Card Menu and associated soft keys are displayed.
3. Press the SAVE WPT/RTE DATA TO CARD or LOAD WPT/RTE DATA FROM CARD soft key; an appropriate warning and Yes/No soft keys are displayed.



D5594-1

4. Press Yes to continue or No to abandon the operation and return to the previous screen.
5. If the operation is successful, confirmation of the number of Routes and Waypoints saved/loaded is displayed.



If the operation fails, the Save Failed message is displayed.



D5596-1



➤ To receive incoming waypoints on SeaTalk or NMEA:

1. To display the waypoint list press **MARKS** followed by the WAYPOINT LIST soft key.
Press the WAYPOINT TRANSFER soft key.
2. Press the soft key RECEIVE WPTS FROM ST/NMEA.
The soft key changes to STOP RECEIVING WAYPOINTS.
When waypoints are transmitted by other equipment they are added to the waypoint list on the chartplotter. Routes transmitted on NMEA are appended to the route list.
3. To disable waypoint transfer, press the soft key STOP RECEIVING WAYPOINTS.
Alternatively, press **ENTER**, or **CLEAR**, twice to close the Waypoint List.



➤ To send the waypoint list on NMEA:

1. Display the waypoint list as previously described, then press the WAYPOINT TRANSFER soft key.
2. Press the soft key SEND WPT LIST ON NMEA.
The soft key changes to STOP SENDING WAYPOINTS.
The waypoint and route lists are transmitted from the chartplotter to other instruments on NMEA.

- To receive the waypoint and route lists via *hsb²*, you must set-up the transfer on both display units - one unit will send waypoints, the other will receive them.

CAUTION:

Receiving waypoints from another *hsb²* instrument overwrites any existing waypoint and route lists.



1. Display the waypoint list as previously described, then press the WAYPOINT TRANSFER soft key.
2. Press the soft key SEND WPT LIST ON HSB or RECIEIVE WPTS FROM HSB. You are prompted to confirm:
Press NO to cancel the operation, then **ENTER** if you wish to close the waypoint list.
Press YES to continue. The waypoint list is transmitted to/from the chart-plotter from/to another instrument on *hsb²*. While the data is being transferred the soft key changes to STOP SENDING WAYPOINTS; when the transfer is complete the soft key is re-displayed.

5.7 Using Tracks

The Track function is used to mark on-screen the trail that your vessel has followed, as if it had left a visible fixed wake.

While the track is switched on it is recorded in the display unit's memory. You specify the interval at which track points are made and a line is drawn on-screen between each point. Up to 4500 track points can be saved in total, in up to 5 track files (each a maximum of 750 points). The current track remains on-screen, even following a power off/on, until you clear the track.

Breaks in the track will be caused when any of the following occur for longer than the specified track interval: the track is switched off then on; the position fix is lost; the display unit is switched off.

To enable you to follow this track on your return voyage, the *SmartRoute* function converts the track (or the last segment of a track with breaks) into a route which is automatically reversed, see *SmartRoute* on page 5-42.

A track can be saved and retrieved for display at a later date. You can only display one track at a time; you must clear a current track from the screen if you want to display a saved track.

This section describes:

- Setting up a track, including how to specify the interval.
- Clearing the current track.

- Managing tracks, using the track list, including Saving, Naming, Erasing and Showing a track.
- Making a Track into a Route

➤ To access the track controls:

1. From the chart display, press the **MENU** key to display the chart set up soft keys.

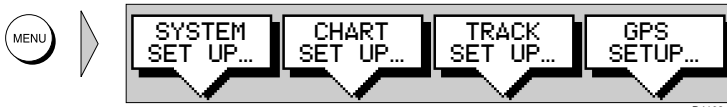

2. Press the TRACK SETUP soft key to display the Track soft keys:



The following instructions assume you have the track soft keys displayed.

Setting Up a Track

You use the track soft keys to switch the track on and to specify the interval, as time or distance, at which track points are saved. The time interval between track points can be set to 1s, 5s, 10s, 30s, 1min, 3min, 5min, 10min or 30minutes. The distance spacing between track points can be set to 0.1nm, 0.5nm or 1.0nm. The interval default is a distance of 0.1nm. The maximum track length is 750 points. When the track has reached this length, the first points are overwritten. The track is saved until you switch it off. When the unit is powered off, the current track (thus far) is retained in memory.

Setting a short time interval between track points is best suited to navigation within a close or complex environment, e.g. an estuary or marina whereas, in contrast, a greater distance interval is best suited to a long haul voyage.

Refer to the setting guide shown in *Figure 5-9* to determine the best setting for your planned voyage; this is particularly important if you wish to use *SmartRoute* to convert your track to a route.

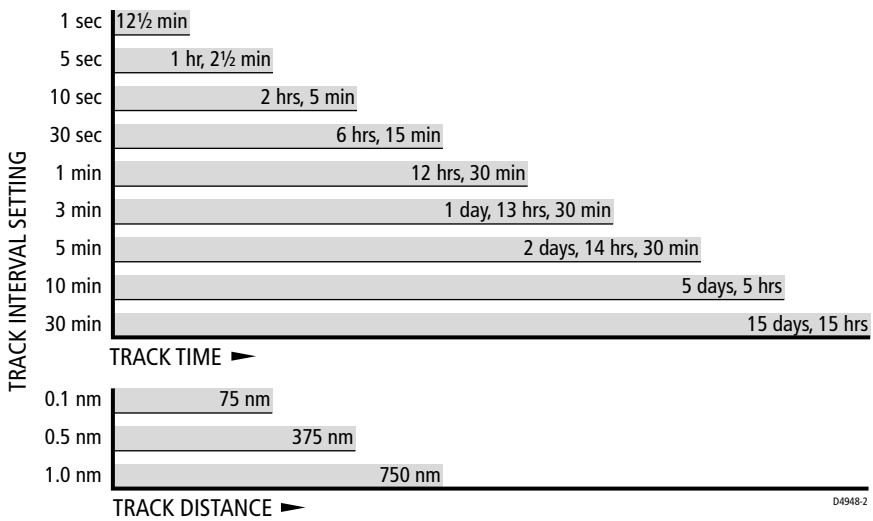
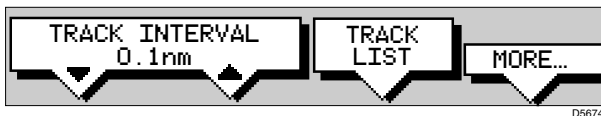

Figure 5-9: Track Interval Setting Guide

You can change the setting at any time. The setting applies only to the current track and is not saved as a stored track.

➤ To set up a track:

1. Press the MORE soft key to access the TRACK INTERVAL soft keys.
Press the appropriate soft key to set either a time interval or a distance interval; press the UP arrow to increase the interval, the DOWN arrow to decrease the interval.
Press **ENTER** to return to the track soft keys.



2. Press the TRACK OFF ON soft key to toggle tracks on.

Your vessels trail will be displayed on-screen, with a line joining the points at the selected interval.

Clearing the Current Track

You can clear the current track from the screen. When you select CLEAR TRACK, if the current track has not been saved, you have the option of saving it.

➤ To clear the current track:



1. Press the CLEAR TRACK soft key.
2. If the track has not been saved the SAVE TRACK soft keys are displayed.



To clear the track without saving it in the Track List, press NO.
To save the track in the list, press YES. The Name track soft keys are displayed and you should continue as described in the following section, Saving and Naming a Track.

Press **CLEAR** to abort the Clear Track operation.

The current track is cleared from the screen and the default soft keys are displayed.

Managing Tracks

Although it is easy to set up a track, and this track is retained even if you switch off your display, you can store a number of different tracks so that you can review them at a later date. This section explains how to perform the following tasks:

- Save and Name a track.
- Name, Erase and Show an existing track.

Saving and Naming a Track

You can save up to 5 named tracks in the Track List. These tracks can be re-displayed at a later date.

► To save and name the current track:



1. Press the MORE soft key followed by the TRACK LIST soft key. The track list pop-up and associated soft keys are displayed.
2. The next available entry on the track list is highlighted.
(If required, you can use the trackpad to select another position in the list; this can be a blank slot, or an existing track that you no longer require).



3. Press SAVE TRACK. The name track soft keys are displayed.

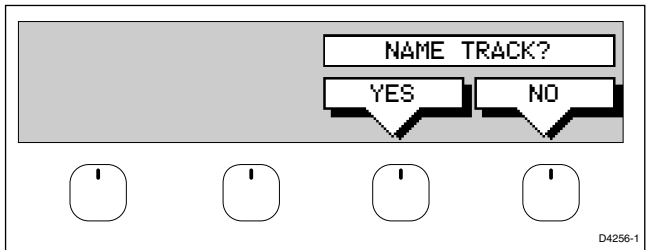

4. If you do not wish to name or rename the track, press the NO soft key (or **CLEAR**) to clear the list. The track is saved and is listed as Track Not Named.

If you wish to name the track press the YES soft key. Use the trackpad to move the cursor right or left to the character you wish to edit. Then use the top or bottom of the trackpad to increase or decrease the letter or number.

You can use a Navigator Keypad (see *Using the ST60 or ST80 Navigator Keypad* on page 5-15) to name the track.

5. Press **ENTER** to finish and clear the Track List, then to return to the default soft key display, press **ENTER** again or **CLEAR**.

Naming, Erasing and Showing a Track

- To name an existing track, erase a track or show a track, you select the track from the track list, then press the appropriate soft key as follows:



1. Press the TRACK LIST soft key. The Track List is displayed. The selection bar indicates the selected track.

Select the required track then press the appropriate soft key.



2. If you NAME a track, use the trackpad to move the cursor right or left to the character you wish to edit. Then use the top or bottom of the trackpad to edit the letter or number. Press **ENTER** finish the operation or **CLEAR** to cancel the name, then **ENTER** to remove the track list.



3. If you ERASE a track you are prompted to confirm.

Press **NO** to cancel the operation, then **ENTER** to remove the track list.

Press **YES** to erase the track from the list, then **ENTER** to remove the track list.



4. If you SHOW a track, and you have a current track on screen, you are prompted to save the track. Proceed as previously described in Clearing the Current Track.

Alternatively, press the **NO** soft key to cancel the SHOW TRACK operation.

The track list is removed and the selected track is displayed.

5. Press **ENTER** or **CLEAR** to return to the default display.

SmartRoute

SmartRoute enables the current track, or the last segment of a track with breaks, to be converted to a route (the track could have been retrieved from the track list). SmartRoute places a waypoint at the last track point, then considers each point in turn and determines the closest route through the recorded track. The number of waypoints created is minimized, whilst maintaining optimum correlation to the recorded track. On completion, the maximum deviation of the route from the recorded track is displayed.

- To convert the current track into a route:

1. Select MAKE INTO ROUTE and press **ENTER**.

The current track is converted to a new route and becomes the current

route, with the most recently placed track point as the start of the route, i.e. the track is reversed.

If there is an unsaved current route on screen, the option to save the route is given, see *Section 5.4, Working with Routes*.

2. Check the calculated route and, in particular, that the route deviation from the original, given in the warning box, is within navigable limits.

CAUTION:

Before following the route, ensure that it is safe for navigation, noting that it may deviate from your actual path travelled.

Chapter 6: Further Chart Operations

6.1 Introduction

This chapter explains how to use the additional functions that are provided on the *hsb²* series chartplotter and combined radar/chartplotter.

It covers the following topics:

- Measuring distances and bearings on the chart, using the **VRM/EBL** key
- Setting alarms and timers
- Man Overboard (MOB)
- Cursor Echo
- GPS Setup
- Data Log Mode

In order to use some of these functions, you may need the following additional data from equipment connected to your system via a *hsb²*, SeaTalk, or NMEA link:

Table 6-1: Function of External Data

Data	Example source	Integrated functions available
Heading COG	Compass* GPS	- Head Up or Course Up heading modes - MOB (if speed data also available) - Radar/Chart Overlay
Radar data	Radar system, via either a combined unit or <i>hsb²</i>	- Radar data, either full-screen or in a half-screen window - Radar/Chart Overlay
Position	GPS system	- Waypoints - Position, COG, SOG and time data in Data Box and Nav Window - MOB - Radar/Chart Overlay - Data Log
Other data	Transducers	- Data Box and Nav Window data displays, including speed, depth, wind, temperature

*If heading data is available via both NMEA and SeaTalk, NMEA data takes priority. For all other data, SeaTalk data takes priority (see).

6.2 Measuring Distances Using the VRM/EBL Key

You can obtain an accurate measurement of the distance and bearing between two points by using the **VRM/EBL** key.

► To place a ruler line and Ruler data box:



1. Position the cursor on the starting point from which you wish to measure.
2. Press **VRM/EBL**.
A Ruler data box is displayed showing the bearing and distance from the starting point to the cursor position. The character **A** appears at the cursor location.
3. Use the trackpad to move the cursor to the measurement end point. A line connects the cursor to the starting point, and the Ruler data box is updated to show the bearing and length of the line as shown in *Figure 6-1*.
4. Press **ENTER** to fix the end point of the ruler line, and return to normal cursor control. The letter **B** marks the location of the end point on the chart.

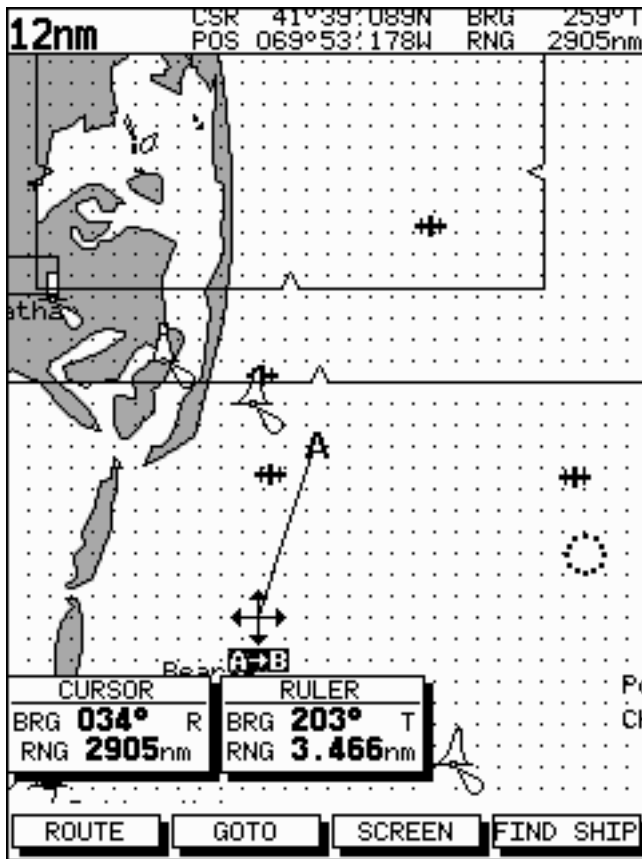

Figure 6-1: Measuring Distance Using a VRM

- To re-position one end of the ruler line:
 1. Move the cursor over the ruler line towards the end that you want to re-position, until the letters A → B are displayed.
 2. Press **ENTER** to take cursor control of the ruler. The ruler end moves to the cursor which changes to a four-headed arrow.
 3. Move the cursor to the required position. The ruler data box is updated.
 4. Press **ENTER** again to set the position and return to normal cursor control. Alternatively, press **CLEAR** to reset the ruler to the previous position.

- To clear the ruler line and ruler data box either:

Move the cursor over the ruler line, until the letters A → B are displayed, then press **CLEAR**.

or:

Press **VRM/EBL**, the ruler soft keys are displayed. Press RULER OFF ON to toggle the ruler line and data box off.



- To clear the ruler data box:

Press **VRM/EBL**, the ruler soft keys are displayed. Press RULER DATABOX OFF ON to toggle the ruler data box off.



- To move the Ruler data box, using the context-sensitive cursor:

1. Move the cursor over the box until the letters BOX are displayed, and press **ENTER** to take cursor control of the box.
2. Use the trackpad to move the box to its new location, and press **ENTER** to drop it and return to normal cursor operation.



6.3 Alarms and Timers

Alarm Reporting



The chartplotter reports the following alarms, that are set using the **ALARMS** key:

Alarm	Indicates:
Arrival	Your vessel has arrived at the active waypoint: it has either reached the arrival circle (the radius of which is specified) or, has reached its closest point of approach (defined by a line passing through the waypoint and perpendicular to the route leg).
Off Track	Your vessel has exceeded the specified distance (maximum cross track error) from the active route leg.
Anchor	Your vessel has drifted from its anchor position (set when the alarm was turned on) by more than the specified distance.
Countdown	The countdown timer has reached zero.
Alarm Clock	The time matches the specified alarm time.

The alarms are switched on or off, and the limits set, using the Alarms Set Up menu, accessed from the **ALARMS** key.

When an alarm is triggered, the alarm buzzer sounds and a pop-up window describing the alarm is displayed.

- To silence the alarm and clear the message, press any key. If the alarm was generated by the chartplotter, the appropriate action is taken. For example, following an arrival alarm, the next route leg is activated. If an anchor alarm is silenced, but the alarm condition persists, the alarm is repeated every 30 seconds.

External Alarms

All SeaTalk system alarms (except autopilot alarms) are received and displayed on the chartplotter. You can silence these alarms by pressing any key. No other action is taken by the chartplotter except to silence the alarm.

Setting Alarms and Timers

► To set up an alarm or timer:



1. Press the **ALARMS** key. The Alarms Set Up menu is displayed, showing the current settings (see *Figure 6-2*).
2. Use the trackpad to move the selection bar up or down the options. As each line is highlighted, the soft key labels are updated to show the current settings and controls.

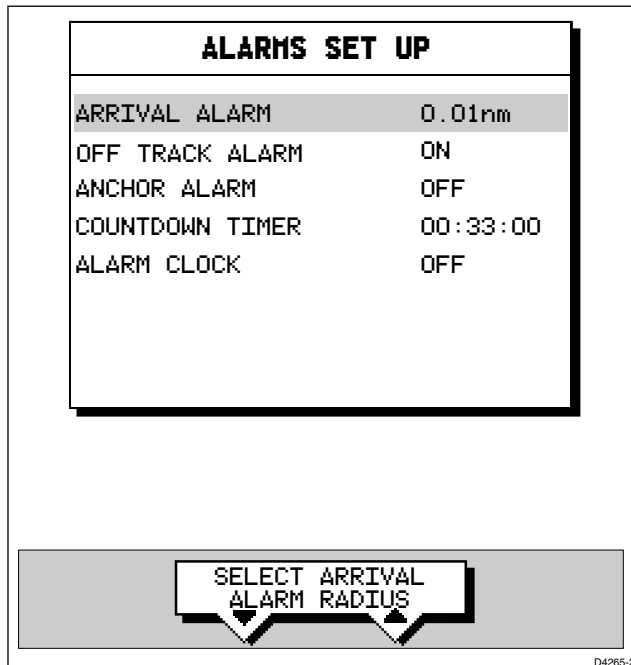

Figure 6-2: Alarms Set Up List

3. Use the up or down soft keys to change the alarm setting. For example, for the arrival alarm you can adjust the radius from the waypoint at which the arrival alarm will be triggered.

The alarm distances can be set in the range 0.01 to 9.99 nm, in steps of 0.01nm. The timer is set in hours, minutes and seconds, and the alarm clock in hours and minutes.



4. If required, press the **ALARM OFF ON** soft key to toggle the alarm on or off. If you turn an alarm off, its value is retained and will be used when you turn the alarm on again.

Note: You can turn all the alarms and timers on and off, except for the Arrival Alarm which is always on.

5. Press **ENTER** to save the changes and clear the list.

6.4 Man Overboard (MOB)

If you lose a person or object overboard, and need to return to the location, you should use the Man Overboard (MOB) function.

You can select the type of data used for the MOB position using the set up menus (see *Section 7.3*).

Note: To obtain MOB position, you need either of the following:

- Position data from a GPS or equivalent device
- Heading and speed data, so that the position can be calculated by dead reckoning

➤ To initiate the MOB procedure, press and hold the **MARKS** key for two seconds. The system then performs the following tasks automatically:



- Redraws the chart at 1/2 nm (even if cartography is not available but plotter mode is on).
- Marks the current position with a MOB symbol  which replaces any current active waypoint and route.
- Displays the MOB data box, showing the bearing and distance from your vessel to the MOB waypoint position, and the elapsed time since the MOB was initiated (*Figure 6-3*).
- Displays the position data box, showing your vessel's position.
- As your vessel moves from the MOB position, a dotted line is displayed connecting the MOB symbol and the vessel's current position.
- Sounds a 4-second alarm pattern every 30 seconds.
- Sends an MOB message (including bearing and distance) to other units in the system, via the SeaTalk connection.

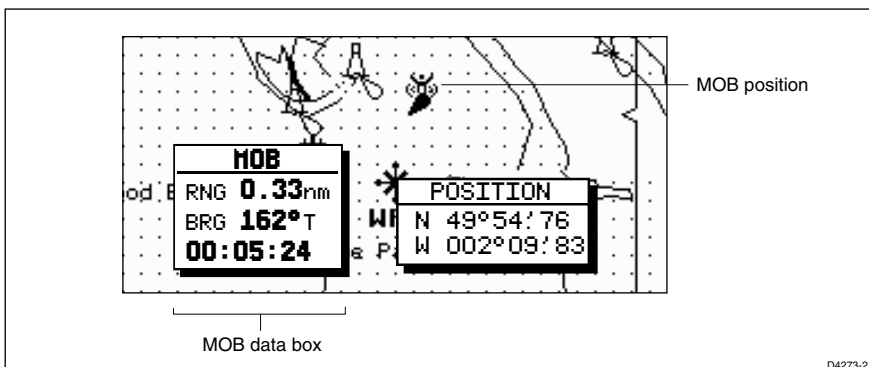

Figure 6-3: MOB Display



- ▶ To cancel the MOB, press and hold the **MARKS** key for 2 seconds. The chart is re-drawn at its previous scale, and the MOB symbol and data box are removed.

Note: *The MOB procedure can also be initiated or cancelled if the appropriate SeaTalk message is received by the display unit.*

6.5 Cursor Echo

In a combined radar/chart display, or in a system with a radar display connected via SeaTalk, you can set the display to enable cursor echo. Cursor echo (accessed from System Set Up, described in *Section 7.3*) enables you to display a radar cursor on the chart picture, or a chart cursor on the radar picture (you cannot display a remote chart cursor in a chart window nor a remote radar cursor in a radar window).

The following options can be toggled ON or OFF:

- **Radar Cursor In:** displays the cursor from another radar on the chart display or chart window (default - OFF).
- **Chart Cursor In:** displays the cursor from another or chartplotter on the radar display or radar window (default - OFF).

Note: *The remote display must have SeaTalk Cursor Out enabled. Raymarine recommend that in multi-display systems, you do **not** enable Cursor Out on more than two displays. If multiple displays have cursor out enabled, the cursors will not be displayed simultaneously, but will flash on/off.*

- **SeaTalk Cursor Out:** enables the output, onto SeaTalk, of the display's own cursor (default - OFF).
- **Cursor Echo Local:** echoes the cursor position between open windows on the same display (default - ON).

If you set the options to OFF, no cursor echo information is displayed.

When the appropriate option is switched on, the display shows its own cursor, plus the cursor of the other display with appropriate cursor text (RDR or CHT) to indicate its origin. This means that you could move the cursor over a target on the radar display, and check the identity of the target by looking at the radar cursor position on the chartplotter.

6.6 GPS Setup

GPS set up page provides you with information and the status of the tracked navigation satellites for a SeaTalk GPS. It also enables you to SET UP a SeaTalk Differential GPS, by manually retuning it to a different differential beacon.

The GPS Navigation Status pop-up window (shown in *Figure 6-4*) provides, for each tracked satellite, the satellite number, a graphical signal strength bar and its current usage status. HDOP and satellite Fix Status are also displayed. Data for up to 12 satellites are shown.

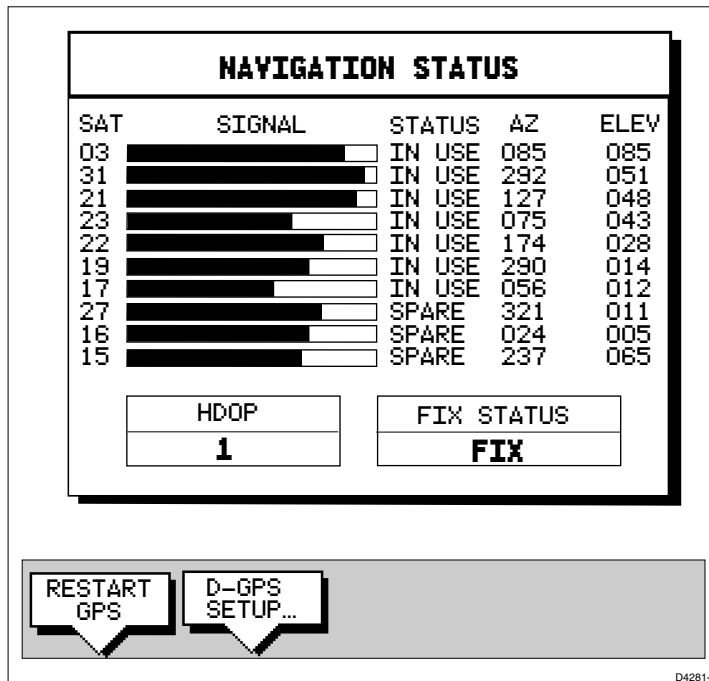

Figure 6-4: Navigation Status Window

Positional accuracy is dependent upon certain parameters; in particular for GPS, the azimuth and elevation angles are used in a triangulation process to calculate position. HDOP (Horizontal Dilution Of Position) is a measure of this accuracy; a higher figure signifies greater error. In ideal circumstances, the figure should be in the region of 1.0. The Fix Status can indicate:

- FIX, where a satellite fix has been acquired.
- D-FIX, where a differential beacon fix has been acquired.
- SD-FIX, where a satellite differential fix has been acquired.
- NO FIX, where no fix can be acquired.

➤ To select GPS Set Up:

Press **MENU**, then press the GPS SETUP... soft key.

The Navigation Status pop-up window shown in *Figure 6-4* is displayed.



Restart GPS

This soft key enables re-acquisition of a GPS position fix.

Note: *Under normal circumstances RESTART GPS is not required.*

D-GPS Set Up

The D-GPS SET UP function provides the ability to set up an external Differential GPS, either automatically (default) or by manually retuning it to a different differential beacon.

In AUTO mode, the D-GPS is set to automatic and beacon selection is made automatically by the beacon receiver. The beacon frequency and bit rate received from the beacon receiver are displayed. The soft keys are disabled and grayed out.

In MANual mode, you can select the beacon frequency and bit rate that are sent to the beacon receiver.

When you select D-GPS SETUP a pop-up window, providing the following parameters, is displayed with associated soft keys:

- Beacon ID - This shows the Beacon ID of the beacon transmitter. If no beacon has been found this item states NOT LOCKED.
- Beacon Frequency - Both the menu item and associated soft keys show the currently used differential beacon's frequency in kHz. The frequency range available is 283.5kHz to 325.0kHz.
- Bit Rate - Both the menu item and associated soft keys show the currently used differential beacon's bit rate in bps. The rates available are 50bps, 100bps and 200bps.
- Signal Strength and Signal to Noise Ratio - These items indicate the received signal strength and Signal to Noise Ratio (SNR) in dB, received from the beacon receiver. If the display unit is using RTCM data received via NMEA, this information is not available and the item shows dashes, one per character. The received Signal Strength and SNR are interrelated. SNR provides a measure of the quality of the received signal and is dependent upon signal strength.
- Differential Age - This indicates the time elapsed since the last differential beacon correction update.

► To tune a differential SeaTalk GPS to another beacon:

1. Press D-GPS SETUP, the Differential GPS Setup pop-up is displayed.
2. Press MODE AUTO MAN to toggle between AUTO and MAN modes; the selected mode is highlighted is indicated in the pop-up window.



Note: *If the display unit is receiving RTCM data via NMEA, repeating a differential fix from another unit, the MODE soft key is set to AUTO and is grayed out. If receiving RTCM data, the setting must be performed manually on the external DGPS receiver.*

3. To set a new beacon manually, press **BEACON SELECT**, use the soft keys to set the required beacon frequency and bit rate.
 Press **ENTER** to return to the Differential GPS Setup pop-up window. The status of the selected beacon is displayed in the pop-up.
 Press **ENTER** to return to the Navigation Status window, then **ENTER** to return to the **MENU** soft keys.

6.7 Data Log Mode

You can set the chartplotter to log course data every thirty minutes. Up to 48 log entries are held, when 48 entries have been made, the chartplotter will start overwriting the first entries.

You start the log using soft keys provided in Data Log Mode. When you select Data Log Mode the log is displayed full-screen. If the screen is full, you use the trackpad to scroll the list and view further log entries. Each line in the log shows:

- Time of log entry
- Position at time of log entry
- Course Made Good (CMG) since last log entry
- Distance Made Good (DMG) since last log entry

Once you have enabled the data log, data is continually logged, but you must set the display to Data Log Mode to view it. You use the **DISPLAY** key to change the full-screen mode.

You can stop the log at any time and you can clear the log from memory.

If the chartplotter is switched off while the log is running, a dashed line will be displayed before the first new entry since switching the chartplotter on again.

- To activate Data Log Mode:



1. Press **DISPLAY**, the DISPLAY pop-up is shown.
2. Press **DISPLAY** again, until LOG is selected, then press **ENTER**.

- To start recording log entries, press the **START LOG** soft key.

As shown in *Figure 6-5*, the chartplotter records the time and vessels position. Every thirty minutes the time, new position, distance made good and course made good are recorded.

START LOG

The **START LOG** soft key changes to **STOP LOG**.

TIME	POSITION	CHG	DHG
15:30	50°21'890N 001°20'610W	346° _M	6.86 _{KM}
16:00	50°18'010N 001°20'070W	180° _M	7.23 _{KM}
16:30	50°21'850N 001°19'290W	012° _M	7.23 _{KM}
17:00	50°18'500N 001°21'300W	206° _M	6.67 _{KM}
17:30	50°20'990N 001°18'280W	043° _M	5.74 _{KM}
18:00	50°19'660N 001°21'960W	245° _M	5.00 _{KM}
18:30	50°19'730N 001°18'030W	093° _M	4.63 _{KM}
19:00	50°20'930N 001°21'750W	302° _M	5.00 _{KM}
19:30	50°18'550N 001°18'650W	145° _M	5.74 _{KM}

STOP LOG
CLEAR LOG

D4284-1

Data Log Mode

Figure 6-5: Data Log Window

- To stop recording log entries:

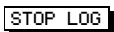

Press the STOP LOG soft key.

- To clear the log entries:

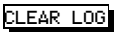

Press the CLEAR LOG soft key, you are prompted “Are You Sure”. To cancel the CLEAR LOG operation press the NO soft key.

To continue press the YES soft key, all log entries are deleted, but the data log remains active.

- To return to the chart display,:



Press **DISPLAY** to select the chart mode, then press **ENTER**.

The log continues until you return to the data log mode and press STOP LOG.



Chapter 7: Setting Up the System Defaults

7.1 Introduction

Once you have installed your display unit and are familiar with its basic operation (described in *Chapter 1* and *Chapter 2*), you need to set it up so that it obtains the correct information from the equipment you have connected it to, operates according to your requirements, and displays information according to your preferences.



This is achieved using the soft key controls that are displayed when you press the **MENU** key.

In most cases, you will only need to use the **MENU** key options when you first set up your system. However, you may decide to change the way you have customized some aspects, such as the screen and help setting, as you become more familiar with your system.

Once you have set the values, they remain as the default settings until you reset them; they are retained even if you power off your display.

This chapter covers the following topics:

- Changing the default set up parameters
- System parameter functions and default settings
- Radar-specific parameter functions and default settings
- MARPA specific parameters and default settings
- Advanced Radar functions
- Chart specific parameter functions and default settings

You should check the functions of the parameters, and decide on the new settings, before making the changes.

Note: *The SYSTEM SET UP menu option from the chartplotter display is the same as that accessed from the radar display SYSTEM SET UP menu.*

7.2 Changing the Set Up Parameters

The set up parameters are divided into four sections:

- **System**, to control the aspects of the system that are not specific to the radar or chart.
- **Radar**, includes bearing alignment, display preferences and the timed transmission option.
- **MARPA**, to control the MARPA target tracking parameters, including target vectors, safe zone and target history display.
- **Advanced**, to control specialist radar settings such as display timing, STC preset and tune preset (see *Section 7.6* for instructions on how to access these functions).
- **Chart**, to control the chartplotter display, including waypoint information, vectors and radar/chart synchronization.

Note: *The GPS and Track Set Up menus are described in Chapter 6.*

This section provides instructions for displaying and changing the default values. The following sections list the parameters and their possible settings, and describe the function of each parameter in turn.

- To set the default parameters:



1. Press the **MENU** key to display the set up soft keys - the options available depend on the selected operating mode.

Radar



Chart

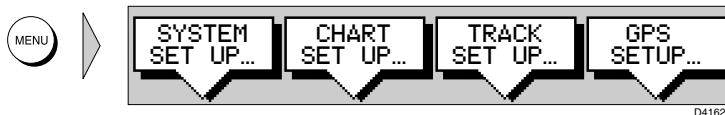

2. Press the soft key for the set up you require.

The requested set up menu is displayed, listing the parameters and their current settings.

3. Use the trackpad to move the selection bar up and down the list. An arrow is displayed at the top or bottom right-hand corner if you can scroll the list to display further parameters.

As each line is highlighted, the soft keys are updated to show the settings available.

- For parameters that have a numeric value, or more than four possible settings, a scroll list is displayed above two of the soft keys.
 - Some parameters are controlled by a slider that is displayed above two of the soft keys.
 - For some parameters, a soft key provides access to a sub-menu of further options.
4. Press the soft key corresponding to the desired setting or, for scroll lists, use the soft keys to scroll forwards or backwards through the list until the required setting is displayed. This setting is retained when you move the selection bar on to the next parameter in the menu list.

For sliders, press the appropriate soft key repeatedly to increase or decrease the slider value in individual steps, or press and hold the key to change the setting quickly.
 5. Once you have set all the required values, press **ENTER** to clear the menu and return to the set up soft keys.
 6. Press **ENTER, MENU** or **CLEAR** to clear the soft keys and return to the default display.

You can return all the settings to their original factory settings, if required, by performing a factory reset as described in *Chapter 9*.

7.3 System Set Up Parameters

The following table lists the System menus and their options, shows the factory default setting, and provides a space for you to make a note of your new default setting. Each parameter is described in the following subsections.

Table 7-1: System Set Up Parameters

Menu	Options	Factory Default	New Default
DATA BOXES			
POSITION	OFF, LAT/LONG, TDs	OFF	
SPEED	OFF or ON	OFF	
DEPTH	OFF or ON	OFF	
COG	OFF or ON	OFF	
SOG	OFF or ON	OFF	
TIME	OFF or ON	OFF	
DATE	OFF or ON	OFF	
WIND	OFF, APP, TRUE or BOTH	OFF	
WAYPOINT	OFF, LAT/LON, or RNG/BRG/TTG	OFF	
	OFF or ON	OFF	
CROSS TRACK ERROR	OFF or ON	OFF	
HEADING	OFF or ON	OFF	
LOG/TRIP	OFF or ON	OFF	
PILOT	OFF, WIND, WPT or BOTH	OFF	
VMG	OFF or ON	OFF	
TEMPERATURE	OFF or ON	OFF	
TIDE SET/DRIFT			
BEARING MODE	MAGNETIC, TRUE	TRUE	
CURSOR REFERENCE	MAG/TRUE, RELATIVE	RELATIVE	
CURSOR READOUT	OFF,LAT/LONG,RNG/ BRG,BOTH	RNG/BRG	
DAY/NIGHT	DAY, NIGHT	DAY	
HELP	OFF/ON	ON	
SOFT KEYS	OFF/ON	ON	
KEY BEEP	OFF/ON	ON	
MOB DATA	DR, POSITION	DR	
MENU TIMEOUT PERIOD	NO TIMEOUT, 10, 20, 30 SECONDS	NO TIMEOUT	
DISTANCE UNITS	NAUTICAL MILES, STATUTE MILES, KILOMETERS, KILOYARDS	NAUTICAL MILES	
SPEED UNITS	KNOTS, MILES PER HOUR, KILOMETERS PER HOUR	KNOTS	
DEPTH UNITS	METERS, FEET, FATHOMS	FEET	

Table 7-1: System Set Up Parameters

Menu	Options	Factory Default	New Default
TEMPERATURE UNITS	CENTIGRADE, FAHRENHEIT	FAHRENHEIT	
VARIATION SOURCE	AUTO, MANUAL	AUTO	
BRIDGE NMEA HEADING	OFF or ON	ON	
NMEA OUT SET UP			
APB	OFF or ON	ON	
BWC	OFF or ON	ON	
BWR	OFF or ON	ON	
DBT,	OFF or ON	ON	
DPT	OFF or ON	ON	
MTW	OFF or ON	ON	
RMB	OFF or ON	ON	
RSD	OFF or ON	ON	
RTE	OFF or ON	ON	
TTM	OFF or ON	ON	
VHW	OFF or ON	ON	
VLW	OFF or ON	ON	
WPL	OFF or ON	ON	
GGA	OFF or ON	ON	
GLL	OFF or ON	ON	
RMA	OFF or ON	ON	
RMC	OFF or ON	ON	
VTG	OFF or ON	ON	
CURSOR ECHO			
RADAR CURSOR IN	OFF or ON	OFF	
CHART CURSOR IN	OFF or ON	OFF	
S/T CURSOR OUT	OFF or ON	OFF	
CURSOR ECHO LOCAL	OFF or ON	ON	
DATE FORMAT	DD/MM/YY, MM/DD/YY	MM/DD/YY	
TIME FORMAT	12 HOUR, 24 HOUR	12 HOUR	
TIME OFFSET	UTC, or local offset value: Plus or minus up to 13 hours, in whole hours	UTC	
GPS SOG/COG FILTER	HIGH, MEDIUM, LOW	MEDIUM	
COMPASS SET UP			
LINEARISE HEADING	Press soft key to start the linearisation procedure and to align the heading	-	
ALIGN HEADING			
LANGUAGE	ENGLISH (UK), ENGLISH (US), DANISH, FRENCH, GERMAN, DUTCH, ITALIAN, ICELANDIC, NORWEGIAN, PORTUGUESE, SPANISH, SWEDISH, FINNISH	ENGLISH (US)	
SIMULATOR	OFF, DATA, RADAR, BOTH	OFF	

Data Boxes

Press the SELECT BOXES soft key to display the data box sub-menu. This allows you to select up to 6 data boxes that you can display on the fishfinder.

Note: 1. A fixed set of 16 of these data items are available for display in the Nav Data half-screen window (see Chapter 2).

2. In addition to these grouped data boxes, boxes for the cursor readout, VRM/EBL data, waypoint data, MOB data and simulator status are displayed when selected or when the appropriate function is active.

3. Radar data is only repeated if the display is connected to an hsb² series radar master display.

Data boxes provide regularly used data in a compact form so that most of the picture can still be seen. The ones you select here can be turned on and off as a group during normal operation, and you can also move them around the screen individually using the context-sensitive cursor (see *Context-Sensitive Cursor Control* on page 1-17.).

Bearing Mode

The mode (magnetic or true) of all the bearing and heading data displayed. This is indicated in the radar status bar after the heading value.

Cursor Reference

The mode of the bearing data displayed for the cursor readout. The bearing information can be displayed in either of two forms:

- Relative: The bearing relative to your vessel's heading.
- Mag/True: The actual bearing in either degrees magnetic or degrees true. This option is only available in Radar mode if your system includes a radar display and you have heading data from a compass.

If you choose this mode, the selection you made for the previous parameter (Bearing Mode), °M or °T, is displayed in the cursor (Rng/Brg) data boxes. The current units are shown for the heading value in the status bar at the top of the screen.

Cursor Readout

This option controls whether the cursor data is shown in latitude and longitude or in range and bearing. Alternatively, you can show both types of readout, in separate boxes, or turn the cursor data box off.

You can also turn the cursor readout box(es) on and off during normal operation, via the SCREEN default soft key (see *Switching the Cursor Data Box On and Off* on page 2-13.)

Day/Night

This option allows you to change the display between day and night modes. If you select NIGHT mode, a different color palette, more suited to night time viewing is used.

Help

When Help is set to ON, a prompt appears when selecting a soft key or menu choice, and when using the context-sensitive cursor. The help message is cleared when an action is selected.

Soft Keys

When the Soft Keys option is set to ON, the default soft keys are displayed if no other operation is in progress.

When the Soft Keys option is set to OFF, the default soft keys are only displayed when a soft key is pressed, and they disappear if no operation is performed for 10 seconds.

Key Beep

This option controls whether or not the keys make a noise when you press them.

MOB Data

This option controls whether MOB data is based on position data, or on dead reckoning (DR). Dead reckoning normally provides a better indication of the course to an object in the water, on the assumption that your vessel and the object are both subject to the same tide and wind effects.

Menu Timeout Period

With no timeout set, menus and soft key labels remain displayed until you clear them by pressing **ENTER**, **CLEAR** or the appropriate dedicated key.

If you set a value here, the menus and soft key labels will be cleared if a key has not been pressed for the specified number of seconds.

This setting does not affect the *default* soft key labels, which are controlled by the Soft Keys option (see above).

Units

You can set the units for speed, depth and temperature. The units you set will be used to display all data, including information received from other instruments on the system. However, the distance units do not affect the instrumented range of the radar, which is always in nautical miles.

Variation Source

The variation value is the difference between True and Magnetic direction data for heading or bearing values. The Variation Source option provides soft keys for selecting Auto or Manual variation mode, displays the current variation value for each and highlights the currently selected mode.

Auto Mode

If you select Auto mode, the display obtains the value of variation automatically, normally from received data. The variation value that is used depends on the data available, and is selected in the following order of priority:

1. Variation value from the same source as the heading data:
 - If heading data is being taken from NMEA, then variation is also taken from NMEA
 - If heading is taken from SeaTalk, then SeaTalk variation is used
2. Variation value from a different source:
 - If heading data is being taken from NMEA, but no NMEA variation is available, then variation is taken from SeaTalk
 - If heading is taken from SeaTalk, but no SeaTalk variation is available, then variation is taken from NMEA
3. A calculated variation value, using position data, if no SeaTalk or NMEA value is available
4. The current manual variation value, if no SeaTalk or NMEA value and no position data is available

Manual Mode

If you select Manual mode, by pressing either of the MANUAL keys, you can specify the local variation value according to the area in which you are operating. Press the appropriate MANUAL key to adjust the variation up or down, to a maximum of 30° East or West.

This value is then transmitted to any other SeaTalk instruments on your system. It is retained if you turn the display off and on again.

In Manual mode, incoming NMEA variation is ignored. However, if the variation is changed on another SeaTalk instrument, the new value is used and the manual value that is displayed is updated.

Note: *The Manual variation value defaults to 0°, so it is important to set up a value if variation is not available from an external source.*

Bridge NMEA Heading

The hsb² series displays bridge NMEA input data to the SeaTalk bus (see Section 8.8). The Bridge NMEA Heading option can be used to prevent NMEA heading data being bridged onto the SeaTalk bus.

For example, if you have a course computer connected on SeaTalk and NMEA, and an active compass connected on NMEA (for MARPA), SeaTalk data overrides NMEA data in the course computer. You should therefore switch OFF the Bridge NMEA Heading option to ensure the course computer receives the same NMEA heading input as the radar system.

NMEA Out Set Up

This option lets you switch off individual NMEA out sentences.

Cursor Echo

You can set up an integrated system so that radar and chartplotter displays connected via SeaTalk can display each other's cursors.

Cursor echo functions so that you can display a chart cursor on the radar picture, or a radar cursor on the chart picture (you cannot display a remote radar cursor in a radar window nor a remote chart cursor in a chart window). When the appropriate options are switched on, each display shows its own cursor, plus the cursor of the other display with appropriate cursor text (RDR or CHT) to indicate its origin. This means that you could move the cursor over a target on the radar display, and check the identity of the target by looking at the radar cursor position on the chartplotter.

Press the CURSOR ECHO soft key to display the cursor transfer soft keys. The following options can be toggled ON or OFF:

- **Radar Cursor In:** displays the cursor from another radar on the chart display or chart window (default - OFF).
- **Chart Cursor In:** displays the cursor from another or chartplotter on the radar display or radar window (default - OFF).

Note: *The remote display must have SeaTalk Cursor Out enabled. Raymarine recommend that in multi-display systems, you do **not** enable Cursor Out on more than two displays. If multiple displays have cursor out enabled, the cursors will not be displayed simultaneously, but will flash on/off.*

- **SeaTalk Cursor Out:** enables the output, onto SeaTalk, of the display's own cursor (default - OFF).
- **Cursor Echo Local:** echoes the cursor position between open windows on the same display (default - ON).

If you set the options to OFF, no cursor echo information is displayed.

Date and Time Settings

Set your preferred date format (DD/MM/YY or MM/DD/YY) and time format (12 or 24 hour). If you wish to display local time, use the soft keys to change from UTC to the required time offset. This can be up to plus or minus 13 hours, in hourly steps.

GPS SOG/COG Filter

The SOG/COG filter averages the velocity vectors to compensate for the oscillating motion of the vessel, giving a clearer indication of the vessel's course and speed. The filter does not affect the calculation of the GPS position.

The velocity vectors calculated from the GPS Signal give an instantaneous measure of speed and direction of the GPS antenna. The COG and SOG can therefore seem erratic under certain conditions. For example, when a vessel is moving slowly through rough seas, the antenna moves from side to side as well as in the direction of the vessel.

Slow moving vessels, or vessels sailing in rough seas will benefit from a high setting, whereas a power boat that can quickly change speed and direction will benefit from a low setting.

Select the SOG/COG filter setting as required. This can be set to HIGH, MEDIUM or LOW.

Compass Set Up

This option is used to calibrate a Raymarine heading sensor such as the Rate Gyro Compass. Controls are provided for Linearise Compass which detects and corrects for heading errors caused by metal objects, and Align Heading which matches the displayed heading to a known heading or transit.

Refer to the Handbook supplied with your heading sensor for more details.

Language

Select the language in which you wish information to be displayed. The selected language will be used for screen text, labels, menus and options, but will not affect the letters displayed by the context-sensitive cursor. The language setting also affects the display format for lat/long position information.

Simulator

The simulator allows you to operate your display without data from the antenna and/or external data sources. The system set up simulator options have the following functions:

- **Data** provides simulated numerical data, and a waypoint display.
- **Radar** provides simulated radar picture, with example targets. The picture does not change if you change the range, although the range rings are adjusted (see *Chapter 3*).
- **Both** provides simulated data and radar picture.

When the simulator is switched on, a SIMULATOR data box is displayed during operation, showing the simulation selected.





7.4 Radar Set Up Parameters

The RADAR SET UP option allows you to set up the radar according to your system configuration and your personal preferences.

Note: *Some parameters can only be changed if you are using the Master display (that is, the display to which the scanner is connected).*

The following table lists the Radar Set Up parameters and their options, shows the factory default setting, and provides a space for you to make a note of your new default setting. Each parameter is described in the following subsections.

Table 7-2: Radar Set Up Parameters

Parameter	Options	Factory Default	New Default
EBL DISPLAY	MAG/TRUE, RELATIVE	RELATIVE	
TIMED TRANSMIT	OFF, ON	OFF	
TRANSMIT PERIOD	10 scans, 20 scans, 30 scans	20 scans	
STANDBY PERIOD	3, 5, 10 or 15 mins	10 minutes	
DEFAULT MARK SYMBOL	 ,  ,  , 		
MARK DISPLAY	OFF, ON	ON	
CLEAR MARKS	Press soft key to clear marks database	N/A	
CUSTOM SCALE	OFF, ON, SET RANGES...	OFF	
BEARING ALIGNMENT	Slider value	0°	
ANTENNA SIZE	4 ft., 6ft (only if an open array scanner is connected)	4 ft.	
SEND ON HSB	ON, OFF	ON	

EBL Display

The mode of the bearing data displayed for Electronic Bearing Lines (EBLs). The bearing information can be displayed in either of two forms:

- **Relative:** The bearing relative to your vessel's heading.
- **Mag/True:** The actual bearing in either degrees magnetic or degrees true. This option is only available if you are obtaining data from a compass.

If you choose this mode, the selection you made for Bearing Mode determines whether °M or °T is displayed in the EBL data boxes. The current units are shown for the heading value in the status bar at the top of the screen.

Timed Transmission Option

The TIMED TRANSMIT parameter, together with the TX PERIOD and STANDBY PERIOD parameters, controls the radar's timed transmission power-saving mode.

When TIMED TRANSMIT is set to ON, the scanner performs the number of scans specified by TX PERIOD and then shuts down for the number of minutes specified by STANDBY PERIOD. While it is shut down, the scanner does not rotate, and the display is in stand-by.

Set the TIMED TX parameter to OFF for normal operation. In this case, the TX PERIOD and STANDBY PERIOD values are ignored.

Note: *Timed Transmission is not available on a Repeater Display.*

Marks Options

You can select the mark symbol that will be used when you place a mark (see *Section 4.3*).

If you turn the MARK DISPLAY option OFF, any marks you have placed are hidden on the display, but retained in the marks database. You can turn the option on again to display them at any time.

To clear all stored marks from the marks database, press the CLEAR MARKS soft key, and the YES soft key to confirm the deletion.

Custom Scale

You can set up your own range scale. When switched ON, this is used instead of the Pathfinder Plus Radar default range scale (see *Section 3.2*).

To set up a scale, press the SET RANGES soft key. The Custom Range Setup Menu is displayed, which allows you to change the maximum range for each range selection.

The following table lists the ranges, shows the factory default setting, and provides a space for you to make a note of your new setting.

Table 7-3: Radar Custom Range Scales

Range	Default Setting (nm)	New Setting (nm)
1	0.125	
2	0.25	
3	0.5	
4	0.75	
5	1.5	
6	3.0	
7	6.0	
8	12.0	
9	24.0*	
10	48.0*	
11	72.0*	

* Maximum range depends on scanner type, refer to the Scanner Owner's Handbook.

To change the range scale, highlight the required range and use the soft keys to change the value. Start at the top of the list and work down, since each value must be greater than the value for the previous range in the list. The following scale increments are available:

Table 7-4: Radar Range Scale Increments

Range Scales (nm)	Scale Increments (nm)
0.125 to 0.5	0.125
0.5 to 3.0	0.25
3.0 to 6.0	0.5
6.0 to 24.0	2.0
24 to maximum for scanner	4.0

When you have finished setting up the new scale, press **ENTER** to return to the Radar Set Up Menu, and press the ON soft key to select your new scale.

Bearing Alignment

The bearing alignment is normally set when you first install your system, and is described in *Radar System Checks and Adjustments* on page 8-17.

The bearing alignment corrects for display azimuth error. It can be set to a value in the range -180° to $+179.5^{\circ}$, in increments of 0.5° .

Antenna Size

This option is used to specify the size of an open array scanner. Refer to the Pathfinder Scanner Owner's handbook for further details.

Send on HSB

SEND ON HSB can be used to stop radar data being transmitted on *hsb*².

If SEND ON HSB is set to OFF, you can view your radar data on the master display, but not on a repeater display.

7.5 MARPA Set Up Parameters

The MARPA set up menu provides options to specify the target vectors, safe zone and target history display.

The following table lists the MARPA Set Up parameters and their options, shows the factory default setting, and provides a space for you to make a note of your new default setting. Each parameter is described in the following subsections.

Table 7-5: MARPA Set Up Parameters

Parameter	Options	Factory Default	New Default
TARGET VECTOR	TRUE RELATIVE	RELATIVE	
VECTOR LENGTH	30 SECS, 1 MIN, 3 MINS, 6 MINS, 12 MINS	3 MINS	
OWN VESSEL SAFE ZONE	0.1 nm, 0.2 nm, 0.5 nm, 1.0 nm, 2.0 nm	0.5 nm	
TIME TO SAFE ZONE	1 MIN, 3 MINS, 6 MINS, 12 MINS, 24 MINS	3 MINS	
SAFE ZONE RING	OFF, ON	ON	
TARGET HISTORY	OFF, 1 MINS, 2 MINS, 4 MINS	OFF	

Target Vector and Predicted Position

The target vector can be True or Relative. True indicates the target's true course and speed over ground. If selected, the vessel's vector is also shown. A Relative vector indicates the target's course and speed relative to your vessel. The length of the vector is determined by the target predicted position after a set time interval.

Safe Zone

The safe zone options are used to set the dangerous target alarm limits.

The safe zone is a ring, centred on your vessel, within which a target is considered dangerous. A target can also be considered dangerous when it is within a specified time of the safe zone. You can switch the safe zone on/off. When the zone is on and a target is acquired, the safe zone ring is displayed.

Target History

Target history can be set to plot the targets' previous position at specified intervals. The four most recent position points are displayed. If True target vectors are selected, then the four most recent vessel position points are also displayed.

7.6 Advanced Settings

The ADVANCED SET UP option allows you to set up values for the following three parameters that affect the fine-tuning of the radar. Advanced settings are only available from the Master radar display (that is, the display connected to the scanner).

Table 7-6: Advanced Radar Set Up Parameters

Parameters	Function	Slider Range
Display timing	Corrects for display range error	0m to 153m
STC preset	Equalizes target levels across display	0-preset maximum
Tune preset	Allows adjustment of the tuning range controlled by the TUNE control	0-255

Note: Under normal circumstances you will not need to adjust these settings, as they are set automatically at the factory. **If these parameters are set incorrectly the performance of the radar will be adversely affected.** Access to the menu is therefore via a hidden key press.

- To change the settings:
 1. Press the **MENU** key to display the set up soft keys.
 2. Press and hold the blank soft key directly to the right of the RADAR SET UP soft key for 5 seconds. The Advanced Settings menu is then displayed.
 3. Use the trackpad to move the selection bar to the required option.
 4. Use the soft keys to increase or decrease the slider setting. As soon as you start to adjust the setting, the menu page is cleared so that you can see the effects of the adjustment on the radar picture, and the radar is set to 1/8nm range.
 5. Press **ENTER** to display the menu again.
 6. Press **CLEAR** to return to the Menu soft keys, and **CLEAR** again to return to normal operation.
- If required, you can recall the factory defaults for this page. To do so, move the selection bar to the SCANNER RESET option, press the ADVANCED SETTING RESET soft key, and press the YES soft key to confirm.

Display Timing

If you extended the inter-unit cable, you should have set the display timing when you first installed your system, as described in *Radar System Checks and Adjustments* on page 8-17.

Under certain circumstances, it may be easier to adjust the display timing with MBS (Main Bang Suppression) off; press the MBS soft key to toggle the setting OFF. MBS is reset to ON automatically when you finish adjusting the display timing.

STC Preset

The Sensitivity Time Control can be adjusted to equalise targets levels across the display. The factory setting should provide an even display, but if you find that targets are brighter or dimmer nearer the centre than at the edge of the display, you can adjust this slider until the required display is achieved.

Note: *Caution should be observed when adjusting this parameter as poor adjustment can adversely affect auto gain and sea controls.*

Tune Preset

The radar tuning is controlled either automatically or manually using the TUNE control (see *Tuning the Receiver* on page 3-9). However, this only controls a restricted range of tuning values. If the actual tuning peak falls outside this range, you will need to adjust the Tune Preset slider to move the controlled range over the tuning peak.

Press the INITIATE SET UP soft key to enable slider control, and adjust for maximum image intensity.





If required, you can press the RESTORE PREVIOUS soft key to reset the Tune Preset to the value before you pressed INITIATE SET UP.

7.7 Chart Set Up Parameters

The CHART SET UP option allows you to set up the chartplotter according to your system configuration and your personal preferences.

The following table lists the Chart Set up parameters and their options, shows the factory default setting, and provides a space for you to make a note of your new default setting. Each parameter is described in the following subsections.

Table 7-7: Chart Set Up Parameters

Parameter	Options	Factory Default	New Default
CUSTOMIZE CHART	See below for details		
PLOTTER MODE	OFF, ON	OFF	
CHART ORIENTATION	NORTH UP, COURSE UP, HEAD UP	NORTH UP	
OBJECT INFORMATION	OFF, ON	ON	
WAYPOINT SYMBOLS	OFF, ON	ON	
WAYPOINT NUMBERS	OFF, OFF	ON	
DEFAULT WAYPOINT SYMBOL	 ,  ,  , 		
HEADING VECTOR	OFF, 3 MINS, 10 MINS, INFINITE	OFF	
COG VECTOR	OFF, 3 MINS, 10 MINS, INFINITE	OFF	
TIDE VECTOR	OFF, 10 MINS, 1 HOUR, INFINITE	OFF	
RADAR/CHART SYNCH	OFF, ON	OFF	
DATUM SELECTION	WGS 84, LOCAL	WGS 84	
POSITION OFFSET	OFF, ON	OFF	

Customize Chart

This provides a list of chart options, enabling you to specify how the chart features are displayed. Most options can be toggled between on, off and custom - custom passes on/off control to the SCREEN soft keys (see *Customizing the Screen Presentation Options* on page 2-13).

The following features can be set using Customize Chart, factory default settings are shown in **bold** type:

- chart text (**on**, off, custom)
- chart text size (small, **normal**, large)
- chart display (**detailed**, simple)
- chart boundaries (**on**, off, custom)
- spot soundings (on, off, **custom**)
- depth shading limit (set the limit)
- depth contours (**on**, off, custom)
- depth contour display (set the upper and lower limits)
- nav marks (**on**, off, custom)
- light sectors (on, off, **custom**)
- caution and routing data (on, **off**, custom)
- marine features (on, off, **custom**)
- land features (**on**, off, custom)
- icon display (simple, **detailed**, custom)

The factory default for CUSTOM options is ON.

Plotter Mode

Plotter Mode enables you to zoom into a smaller area, even when no chart data is available for that scale. This allows you use the chartplotter functions at large scales even when a chart card is not installed.

Chart Orientation

The chart orientation is normally North Up, but can be changed to Course Up or Head Up if heading data is available. The orientation modes give the following displays:

- **North Up:** The chart is displayed with north upwards. As you change heading, the ship's heading marker moves. This is the default mode, and is the only mode available if there is no heading data.
- **Course Up:** The chart is stabilized and displayed with the currently selected course upwards. If you select a new course, the picture rotates to display the new course upwards.

The reference used for the Course Up depends on the information available. The first available in the following is used:

- i. A locked heading over a SeaTalk connection
- ii. The heading at the time Course Up was selected

To update the Course Up reference while Course Up is the current mode, re-select Course Up from the set up menu.

- **Head Up:** The chart is displayed with the vessel's current heading upwards. As the heading changes the chart will rotate.

Object Information

You can set Object Information ON or OFF. When set ON, object information is displayed in normal chartplotter operation when the cursor is placed over a chart object for two seconds. When set OFF, no information is displayed.

Waypoint Options

Waypoint Symbols controls whether or not the waypoints are shown on the Chart display, with their appropriate symbols. The active waypoint, and waypoints in the current route are always shown.

Waypoint Numbers controls whether or not the waypoint numbers are shown for any waypoints in the current route.

Default Waypoint Symbol lets you select the symbol you want used for waypoint display.

Vectors

Heading, Tide and Course Over Ground vectors can be displayed as a line from your vessel. The length of the vector is determined by your choice of SOG and the time period. An infinite vector extends to the edge of the chart screen.

Heading Vector indicates your current heading.

COG Vector indicates your course over ground.

Tide Vector indicates the tide angle. Tide information is calculated from the speed through water, compass and position data.

Radar/Chart Synch

If you have a combined radar/chartplotter display you can select Radar/Chart Synch ON or OFF. When set ON with chart and radar windows displayed, FIND SHIP can be used to synchronize the radar and chart images.

The chart is redrawn so that its centre matches that of the radar display. The radar is redrawn to the scale and heading mode of the chart.

Datum Selection

You can select either WGS 84 or LOCAL datum. In LOCAL mode, you are presented with a list of datums; use the trackpad to scroll through the list, then press **ENTER** to select the option and close the menu.

CAUTION:

Changing the chart datum does *not* cause any waypoint or routes stored in the chartplotter to move on the display, although their latitude and longitude changes to reflect the new datum.

When adding waypoints numerically to the waypoint list, or via SeaTalk, NMEA or *hsb²*, it is important that they are referenced to the same datum to which the display is currently set.

When you change datum selection, the system attempts to set any connected GPS to the new mode, using SeaTalk and NMEA set up commands. A message shows whether the set up was successful or not.

Position Offset

You can offset the vessel position to allow for differences between the GPS and paper chart data. This may be useful if you are using a datum that is not available on the Chartplotter, or if you are referring to a paper chart drawn to unknown datum.

You can change the offset by moving the cursor to the known vessel position. This offset is applied to all incoming position data. The default offset value is zero.

When position offset is switched on, all displayed vessel position data is annotated (C) to indicate it has been corrected.

- To switch the position offset on/off:
 1. Select the POSITION OFFSET option, then press the OFFSET OFF ON soft key to toggle the option on/off. The last selected offset value is added to position data and the vessel is displayed at the corrected position.
- To set a new offset value:
 1. Select the POSITION OFFSET option, then press the SET UP OFFSET soft key. If necessary, position offset is automatically toggled on.
 2. Use the trackpad to move the cursor to the required vessel position; the cursor position is displayed in a position offset data box.
 3. Press the ACCEPT OFFSET soft key, the vessel is displayed at the new position. Press **ENTER** to return to the default display.
- To set the offset value to zero:
 1. Select the POSITION OFFSET option, then press the SET UP OFFSET soft key
 2. Press the CANCEL OFFSET soft key. The position offset value is set to zero.

Note: *If you wish to practice using the display before installation, connect a 12V or 24V DC power supply (connecting the red wire via a 6.3A quick blow fuse to positive and the black wire to negative) and using the simulator mode, as described in Chapter 2.*

For full functionality of the radar and chartplotter you need to provide position and heading data.

- Orientation - heading data is required for the radar to operate in North Up and Head Up mode and the chart to operate in Course Up and Head Up.
- MOB requires heading and speed data. Alternatively, SOG and COG (derived from the same source as position data) enable the MOB function.
- MARPA and radar/chart overlay require accurate heading data; full MARPA functionality is provided if SOG and COG are also available.
- Position data is required for full functionality of the chart display.

Full details of heading, position and other data are given in *Section 8.8*.

Planning the Installation

Before you install your system, plan the installation, considering:

- Location of the display unit, as described in *Section 8.3*
- Cable Runs, including cables for an integrated system (to provide heading and position data etc.), as described in *Section 8.4*.

EMC Installation Guidelines

All Raymarine equipment and accessories are designed to the best industry standards for use in the recreational marine environment.

Their design and manufacture conforms to the appropriate Electromagnetic Compatibility (EMC) standards, but correct installation is required to ensure that performance is not compromised. Although every effort has been taken to ensure that they will perform under all conditions, it is important to understand what factors could affect the operation of the product.

The guidelines given here describe the conditions for optimum EMC performance, but it is recognized that it may not be possible to meet all of these conditions in all situations. To ensure the best possible conditions for EMC performance within the constraints imposed by any location, always ensure the maximum separation possible between different items of electrical equipment.

For **optimum** EMC performance, it is recommended that **wherever possible**:

- Raymarine equipment and cables connected to it are:

- At least 3 ft (1 m) from any equipment transmitting or cables carrying radio signals e.g. VHF radios, cables and antennas. In the case of SSB radios, the distance should be increased to 7 ft (2 m).
- More than 7 ft (2 m) from the path of a radar beam. A radar beam can normally be assumed to spread 20 degrees above and below the radiating element.
- The equipment is supplied from a separate battery from that used for engine start. Voltage drops below 10 V, and starter motor transients, can cause the equipment to reset. This will not damage the equipment, but may cause the loss of some information and may change the operating mode.
- Raymarine specified cables are used. Cutting and rejoining these cables can compromise EMC performance and must be avoided unless doing so is detailed in the installation manual.
- If a suppression ferrite is attached to a cable, this ferrite should not be removed. If the ferrite needs to be removed during installation it must be reassembled in the same position.

Suppression Ferrites

The following illustration shows typical cable suppression ferrites used with Raymarine equipment. Always use the ferrites supplied by Raymarine.

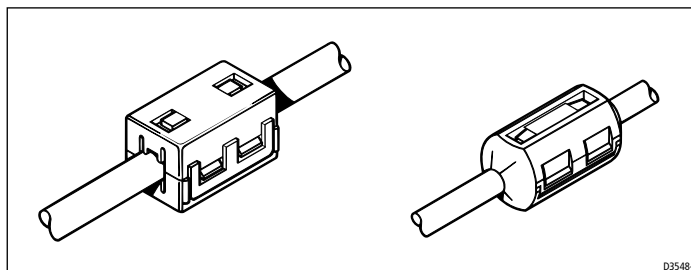

Figure 8-2: Typical Suppression Ferrites

Connections to Other Equipment

If your Raymarine equipment is to be connected to other equipment using a cable not supplied by Raymarine, a suppression ferrite **MUST** always be attached to the cable near to the Raymarine unit.

8.2 Unpacking and Inspecting the Components

Unpack your system carefully, to prevent damage to the equipment. Save the carton and packing, in case you need to return a unit for service.

Check that you have all the correct system components. These depend on your system package, as follows:

Table 8-1: Parts and Accessories

Item	Part No	Supplied with:	Option for:
7"/10.4" Color LCD Display	E52033/E52037	RL70C/RL80C PLUS	-
	E52034/E52038	RL70CRC/RL80CRC PLUS	-
	E32035/E32036	RC530/RC631 PLUS	-
Color LCD Display Accessories			
7" Sun cover	D331	RL70C/RL70CRC/RC530 PLUS	-
10.4" Sun cover	E55031	RL80C/RL80CRC/RC631 PLUS	-
Handbook, Radar/Chart	81188	All	-
Quick Reference Card, Radar	86058	RL70C/RL80C/RL70CRC/ RL80CRC PLUS	-
Quick Reference Card, Chart	86059	RC530/RC631/RL70CRC/ RL80CRC PLUS	-
7" Mounting bracket assy	W143	RL70C/RL70CRC/RC530 PLUS	-
10.4" Mounting bracket assy	E55032	RL80C/RL80CRC/RC631 PLUS	-
Trunnion knobs (x2)	W145	All	-
7" Flush Mount Kit	M92708	-	RL70C/CRC/ RC530 PLUS
10.4" Flush Mount Kit	E55033	-	RL80C/CRC/ RC631 PLUS
Power cable	W144	All	-
Seataalk cable assembly - Flat moulded plugs both ends:			
3 ft 3 in (1 m) long	W284	-	All
9 ft 9 in (3 m) long	W285	-	All
16 ft 3 in (5 m) long	W286	-	All
29 ft 3 in (9 m)) long	W287	-	All
Flat to male round connector:			
12 in (0.3 m) long	D187	-	All
Flat to female round connector:			
12 in (0.3 m) long	D188	-	All
Flat moulded plug one end only:			
3 ft. 3 in (1 m) long	D229	-	All
Ferrite for SeaTalk Cable	-	All	-
Seataalk junction 3-way block	D244	-	-
Seataalk auxiliary junction box	R55006	All	-
<i>hsb²</i> cable assy			
3 ft 3 in (1 m)	R55001	-	All
10 ft (3 m)	R55002	-	All
20 ft (6 m)	R55003	-	All
30 ft (10 m)	R55004	-	All
60 ft (20m)	E55010	-	All
<i>hsb²</i> Splitter	E55040	-	All
In-line Terminator	R58117	All	-
NMEA OUT cable assy			
4 ft 11 in (1.5m)	R55005	All	-

8.3 Selecting the Display Unit Location

The display unit can be mounted using the mounting bracket supplied, or console mounted using the optional flush-mounting kit.

The dimensions of the display units, including the bracket, are shown in *Figure 8-3* and *Figure 8-4*.

When planning the display installation, the following should be considered to ensure reliable and trouble free operation:

- **Convenience:** The contrast and colors seen on all LCD displays vary slightly with viewing angle; this is more noticeable on the left hand side. Power the unit and select a suitable mounting location prior to installing the display.
The mounting location should be easily accessible to allow operation of the front panel controls.
- **Access:** There must be sufficient space behind the display to allow cable connections to the rear panel connectors, avoiding tight bends in the cable.
- **Interference:** The selected location should be far enough away from devices that may cause interference, such as motors, generators and radio transmitter/receivers (see the EMC guidelines earlier in this section).
- **Magnetic compass:** Mount the display unit at least 3 ft (1m) away from a magnetic compass.
- **Cable runs:** The display unit must be located near a DC power source. The power cable supplied is 4.9 ft. (1.5m), but a longer cable can be used if required: refer to *Section 8.4*.

The maximum length of cable between a master display and the scanner unit should not normally exceed 60 ft. (20 m). If you need to use a longer cable, refer to the *Pathfinder Radar Scanner Owner's Handbook*.

- **Environment: Do not restrict airflow at the rear of the display unit; the display incorporates Cold Cathode Florescent Lamps (CCFL), which have a reduced light output when the unit is very hot. Ensure there is adequate ventilation, particularly if the display unit is pod-mounted.** The display should be protected from physical damage and excessive vibration. Although the display unit is waterproof, it is good practice to mount it in a protected area away from prolonged and direct exposure to rain and salt spray.

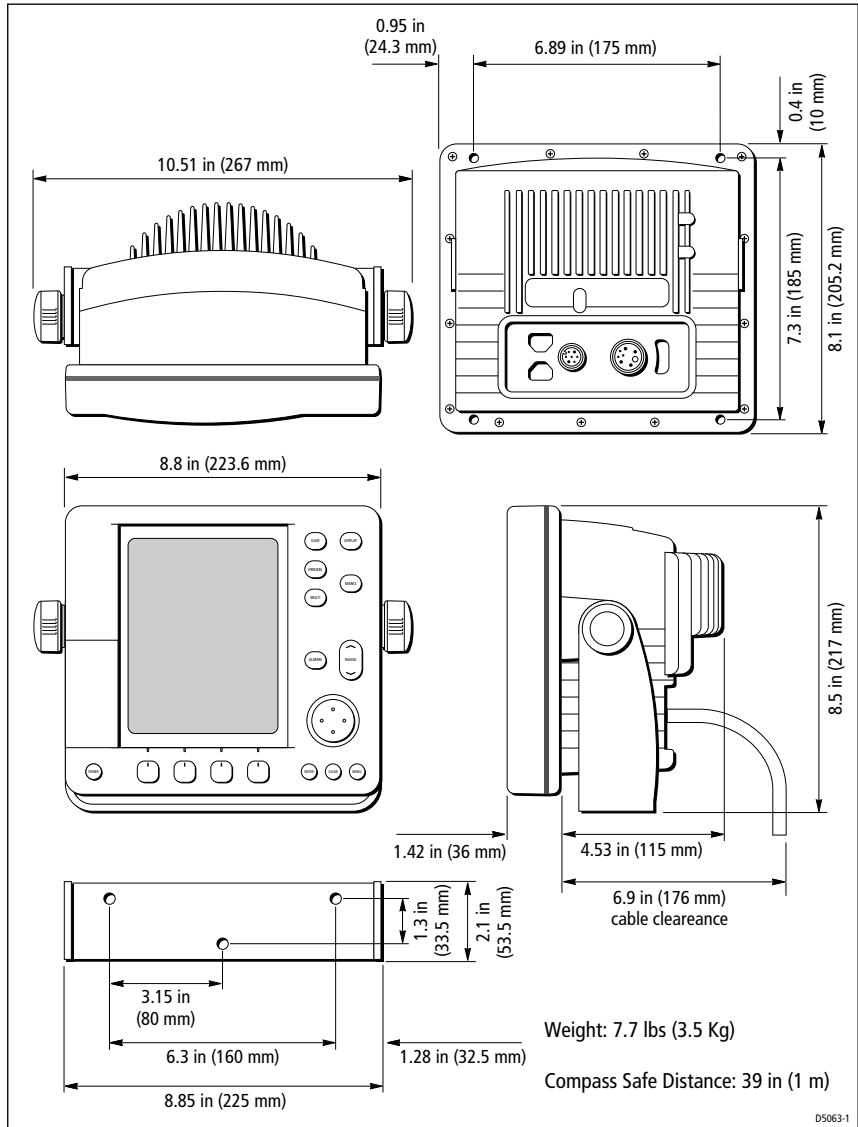

Selecting the Display
Unit Location

Figure 8-3: 7" LCD Color Display Dimensions

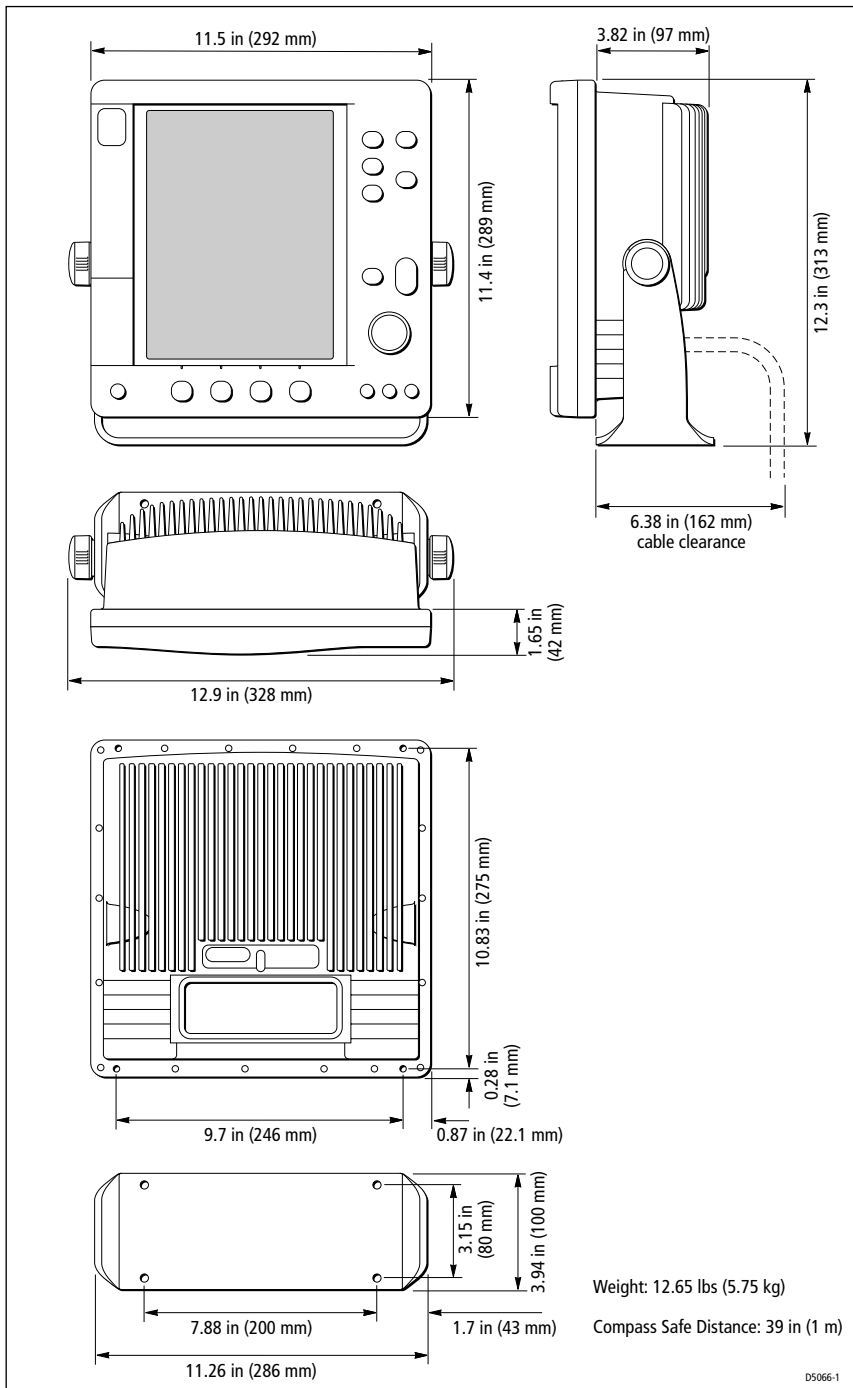

Figure 8-4: 10.4" LCD Color Display Dimensions

Selecting the Display Unit Location

8.4 Cable Runs

Consider the following before installing the system cables:

- You need to attach the power cable and the scanner cable. Additional cables will be required if you are installing an integrated system.
- All cables should be adequately secured, protected from physical damage and protected from exposure to heat. Avoid running cables through bilges or doorways, or close to moving or hot objects.
- Acute bends must be avoided
- Where a cable passes through an exposed bulkhead or deckhead, a water-tight feed-through should be used.
- Secure cables in place using tie-wraps or lacing twine. Coil any extra cable and tie it out of the way.

You need to run the following cables:

- **Power/NMEA Input cable**, supplied with the display unit. This has a connector plug at one end for connecting the display unit, and 7 wires at the other end for connecting the power supply and optional NMEA inputs (see *Section 8.8, Integrated Systems*).
- **Inter-unit cable**, supplied with the scanner unit. This is Vinyl-covered and shielded, with a connector plug at one end for connecting to the display unit or extension cable.
- **SeaTalk cable**, optional, with SeaTalk connector(s) at one or both ends.
- **hsb² cable**, required for multi-display systems.
- **NMEA Output cable**, optional, with an NMEA OUT connector at one end only.

Power Cable

The hsb² series display system (i.e. with a scanner connected where applicable) is intended for use on ships' DC power systems rated as follows:

12 V or 24 V systems	Radome Scanner System
12 V, 24 V or 32 V systems	4 kW Open Array Scanners System; RC530/631
24 V or 32 V systems	10 kW Open Array Scanners System

A 5 ft. (1.5 m) power cable is supplied for connecting the ship's DC power to the display unit. Longer power cable runs may require larger wire gauges to minimise any voltage drop in the cable. The scanner type and the length and type of the inter-unit cable also affect the wire gauge required for the extension power cable. For further details on the master display power cable length refer to the *Pathfinder Plus Radar Scanner Owner's Handbook*.

If a longer power cable run is required, use the supplied power cable to connect to the display unit. Then use a suitable connector block to connect the free end to the extension cable, taking particular care to ensure correct polarity. The supplied power cable has a cross-section of 2.0 mm².

Note: *For repeater displays, the power cable may be extended by up to 20 m using a wire gauge of 1.5 mm² (AWG 16) or greater, irrespective of the inter-unit cable length.*

Inter-Unit Scanner Cable

The inter-unit (scanner) cable entrance is at the rear of the scanner unit. If the unit is mounted on a hollow mast the cable may be run inside the mast and then fed through the radar's cable entrance. Make sure that the cable does not chafe where it enters the mast.

Note: *Route the cable from the display up to the scanner, since this will require the smallest clearance hole.*

The type of inter-unit cable, for connecting the scanner to the display unit, depends on your scanner package. Refer to the *Pathfinder Plus Radar Scanner Owner's Handbook* for details, which include length considerations and bending radii.

hsb² Cable

The number of *hsb²* (PLUS) display units that can be connected is limited by the total cable length.

For example:

10 units Max. total cable length - 40 m

8 units Max. total cable length - 60 m

Note: *If you have fewer displays, it may be possible to have more than 60 metres of cable and conversely, if your total cable length is less than 40 metres, it may be possible to connect more *hsb²* displays. Contact your authorized Raymarine dealer for further details.*

CAUTION:

Do not cut nor rejoin the HSB cable - this will result in signal degradation.

8.5 Mounting the Display Unit

The *hsb²* series LCD display unit is waterproof to CFR46 and can be installed either above or below deck. The display unit can be mounted using the mounting bracket supplied, or console mounted using the optional flush-mounting kit (see *Section 8.2*).

Mounting Bracket

The display unit can be mounted on a dash, chart table, bulkhead or deckhead.

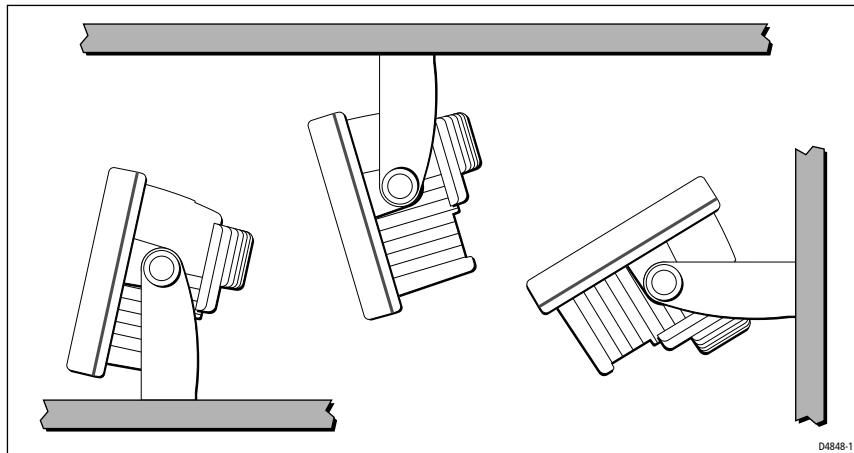

Figure 8-5: LCD Display Mounting

1. Loosen the knobs and remove the mounting bracket from the display unit.
2. Mark the locations of the mounting bracket screw holes on the mounting surface.
3. Use the screws supplied to attach the mounting bracket at the marked locations.
4. Attach the display unit to the mounting bracket, adjust the display angle and tighten the knobs.

Console Mounting

The display unit can be console mounted if required, using the optional flush-mounting kit (M92708).

CAUTION:

Make sure there are no hidden electrical wires or other items behind the location before proceeding. Make sure there is sufficient rear access for mounting and cabling.

1. Check the selected location for the unit. A clear, flat area at least 9 in (230 mm) wide by 8¼ in (210 mm) high, with at least 6.9 in (176 mm) of clearance behind the panel, is required.
2. Unpack the flush-mounting kit.
3. Using the supplied template, trace out the display unit opening.
4. Drill a ½ in (12.7 mm) pilot hole in each corner of the cut-out area.
5. Using a suitable saw, cut along the inside edge of the cut-out line.
6. Remove the mounting bracket knobs and bracket from the display unit. Make sure that the unit fits in the cut-out area.

If the optional screw fitting is required, drill four 3/16 in (5 mm) holes as indicated on the template.

Screw the studs into the holes provided at the rear of the display.

7. Connect the DC power cable, inter-unit cable, and any other accessory cables to the display. Avoid tight bends in the cables.
8. Place the gasket on the unit and slide the unit into the panel cut-out.
9. Use the flush-mounting kit to secure the unit to the console.

Alternatively, place a spacer over each of the four studs and secure with the thumb nuts.

8.6 System Connections

Grounding the System

It is important that an effective RF ground is connected to the system. You must ground the display by connecting the drain wire (shield) of the Power/NMEA Input cable to the nearest ground point of the ship's RF ground system.

If you need to extend the wire, the extension wire should be an 8 mm braid or AWG 10 (6.0 mm²) multi-stranded cable.

If your vessel does not have an RF system, connect the drain wire to the negative battery terminal.

DC Power Connection

The *hsb²* series display is intended for use on ships' DC power systems rated at 12 V, 24 V or 32 V. However, the operating voltage of the radar and radar/chartplotter displays is limited by the scanner to which it is connected as follows:

12 V and 24 V systems	Radome Scanner System
12 V, 24 V or 32 V	4 kW Open Array Scanner System; RC530/RC631
24 V or 32 V	10 kW Open Array Scanner System

The power connection to the display should be made at either the output of the battery isolator switch, or at a DC power distribution panel.

Raymarine recommends that power is fed directly to the display via its own dedicated cable system and MUST be protected by a thermal circuit breaker or fuse, installed close to the power connection.

The DC system should be either:

- Negative grounded, with the negative battery terminal connected to the ships ground.
- Floating, with neither battery terminal connected to the ships ground.

CAUTION:

This system is not intended for use on “positive” ground vessels.

The power cable Ground (earth) connections must be connected to the ship's ground as described above.

Power for External Equipment

External equipment cannot be powered from the display's SeaTalk interface.

It must be powered from the ship's supply or via a SeaTalk bus.

Refer to *Section 8.8* for further details.

Display Unit Connection

The rear of the *hsb²* series LCD display provides the following connection sockets:

- **Scanner (antenna)** connection
- *hsb²*, in/out connector for connecting to another *hsb²* or HSB series display.
- **SeaTalk**, for SeaTalk data input and output and connecting to another *hsb²* series display (such as a chartplotter or second radar display).
- **NMEA Output**, for NMEA data output in an integrated system.
- **Power/NMEA Input**, for 12 V, 24 V or 32 V DC power connection, two NMEA 0183 inputs and one RF ground (screen) connection.

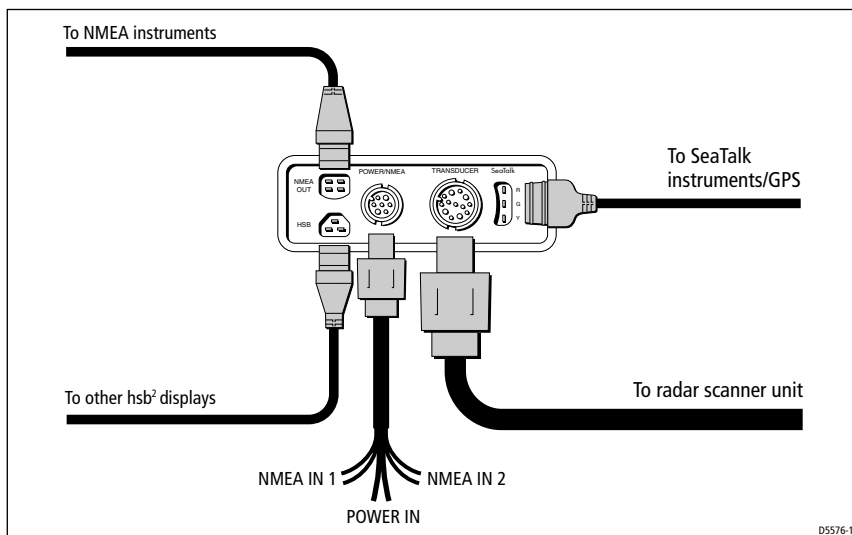

Figure 8-6: Radar Display Connector Panel

The following sections detail the display unit connectors used when installing a single *hsb²* series LCD Display. The remaining connector details are provided in *Section 8.8*.

Scanner Connection (master displays)

Connect the inter-unit cable plug to the rear scanner connector. If you are using an inter-unit extension cable, connect this to the display unit, and connect the supplied cable to the extension cable.

The scanner connector pins are shown in the following diagram, together with the connections and core colours.

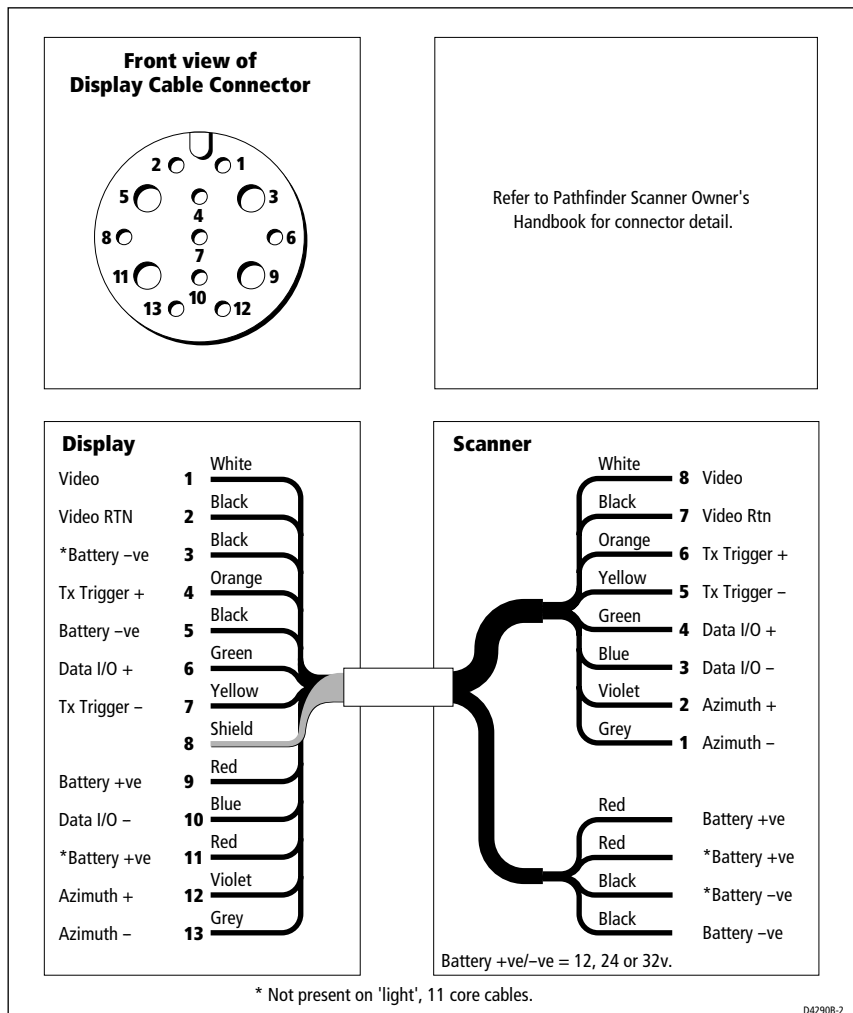
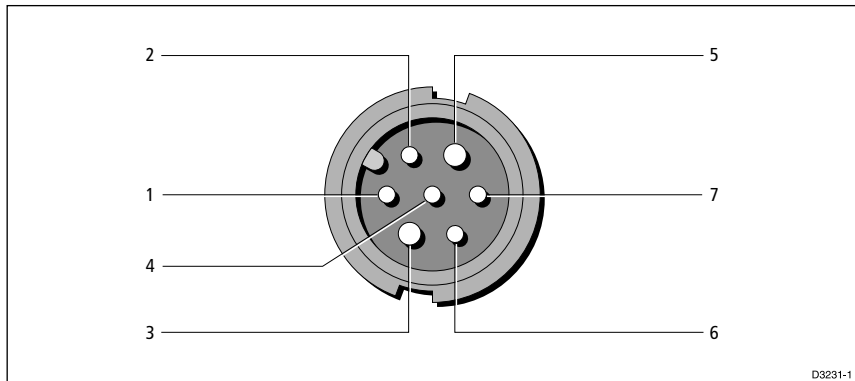

Figure 8-7: Radar Scanner Connection

The *hsb²* cable is supplied with a blanking plug for the scanner connector socket. This should be attached to the repeater display. If the repeater display is installed in an exposed position seal the blanking plate with silicon compound.

Power and NMEA Input Connection

The DC power and NMEA input should be connected at the rear Power/ NMEA seven-pin connector. The connector (viewed from the outside) and pin functions are shown in the following diagram and table. The NMEA Input is detailed in *Section 8.8*.



Pin No.	Function	Color
1	Channel 1 NMEA data input (+ve)	Orange
2	Channel 1 NMEA return (-ve)	Yellow
3	Battery negative	Black
4	Shield (drain wire)	No insulation
5	Battery positive (12/24/32 V systems)	Red
6	Channel 2 NMEA data input (+ve)	Green
7	Channel 2 NMEA return (-ve)	Blue

Figure 8-8: Power and NMEA Connector

Power Connection

CAUTION:

If the power connections are accidentally reversed the system will not work. Use a multimeter to ensure that the input power leads are connected for correct polarity.

Switch off the display unit before you remove the power cord.

The RED wire must be connected to the feed from the positive (+) battery terminal and the BLACK wire to the feed from the negative (-) battery terminal. The shielded wire (screen) should be connected to the ship's RF ground as previously described in *Grounding the System* on page 8-12.

Any unused wires should be insulated and taped back.

8.7 Radar System Tests and Installation Alignment

Once you have installed your Pathfinder Plus Radar System and made all the connections, you need to check your installation and perform the *System Tests* before using the system for navigation. It is strongly recommended that the System Tests are performed before connecting the radar to other equipment in an integrated system. If you have extended your inter-unit cable, you will also need to check the display timing. If you encounter any problems, refer to *Chapter 9*.

You may wish to read *Chapters 2 to 4*, and familiarise yourself with the operation of the system, before performing the initial set up and alignment.

System Check

Before performing the functional test, check the following:

- All securing bolts are fully tightened and mechanical locking arrangements as specified are in place.
- Scanner and power connections have been made.
On the open array scanner, set the power switch (on the pedestal) ON.
- All connecting wires are secured and protected as necessary.

Note: *If you are the boat owner and have performed the installation yourself, ask your authorised installation dealer to check the installation before going to sea.*

Switch On and Initial Setup

To switch on the display unit, press and hold the **POWER** key until the unit beeps. Since the display is a radar master, the magnetron warm-up sequence should start, after which the unit should enter Stand-by mode.

The display switches on in the last used mode. If it is necessary to change the mode, press **DISPLAY** to show the Display pop-up. Press **DISPLAY** again, as necessary, to select Radar mode, then press **ENTER**.

If necessary, adjust the lighting (see *Changing the Brightness* on page 2-6).

If required, change the default language settings as follows:

1. Press the **MENU** key to display the setup soft keys.



2. Press the SYSTEM SET UP soft key.

The SYSTEM SET UP menu is displayed, listing the parameters and their current settings. The complete list, which you can scroll down, is shown in the following illustration.

SYSTEM SET UP MENU	
DATA BOXES	
BEARING MODE	TRUE
CURSOR REFERENCE	RELATIVE
CURSOR READOUT	RNG/BRG
DAY/NIGHT	RNG/BRG
HELP	ON
SOFT KEYS	ON
KEY BEEP	ON
MOB DATA	DR
MENU TIMEOUT PERIOD	NO TIMEOUT
DISTANCE UNITS	NAUTICAL MILES
SPEED UNITS	KNOTS
DEPTH UNITS	METRES
TEMPERATURE UNITS	CENTIGRADE
VARIATION SOURCE	AUTOMATIC
BRIDGE NMEA HEADING	ON
NMEA-OUT SET UP	
CURSOR ECHO	
DATE FORMAT	DD/MM/YY
TIME FORMAT	24 HOUR
TIME OFFSET	UTC
GPS SOG COG FILTER	MEDIUM <input type="checkbox"/>
COMPASS SET UP	
LANGUAGE	ENGLISH (US)
SIMULATOR	OFF

Figure 8-9: System Set Up Menu

3. Use the trackpad to move the selection bar down to the LANGUAGE option. the soft key labels are updated.
4. Use the soft keys to highlight the required language.
5. Press **ENTER** to return to the setup soft keys.
6. Press **CLEAR** to return to the normal radar screen.

Radar System Checks and Adjustments

When the display is connected to a scanner unit you should perform the checks and adjustments detailed below.

Transmission Check

WARNING:

The radar scanner transmits electromagnetic energy. Ensure that the scanner has been installed according to the recommendations given in the *Pathfinder Plus Radar Scanner Owner's Handbook*, and that all personnel are clear of the scanner, before switching to transmit mode.

Ensure the display unit is in Radar mode.

To switch to transmit mode, press and release the **POWER** key. The antenna sweep should start to build up the radar picture.

Run through the operations described in *Chapter 3* and check that all the expected data is displayed.

Bearing Alignment

When the system is correctly installed, you must check the bearing alignment to ensure that targets appear at their correct bearing relative to the ship's bow, and adjust the alignment if necessary.

To adjust the alignment, you need to select a visible target of known bearing that is displayed on the radar, and then use the setup options to adjust the radar until the correct bearing reading is obtained.

- ▶ To determine the alignment error, use one of the methods detailed below.
 1. Visually identify a suitable target, such as a buoy that can be seen towards the edge of the radar screen. Typically, this will be on the 1.5 nm range.
 2. If the vessel is moored:
 - i. Determine the accurate bearing of the target relative to the ship's bow with the aid of a hand bearing compass. i.e. Subtract the ship's head bearing from the target visual bearing.

Example 1

Visual bearing = 065°M

Ship's head = 021°M

Relative bearing = 044°R

Example 2

Visual bearing = 030°M

Ship's head = 042°M

Relative bearing = -012°(+360) = 348°R

- ii. Measure the relative bearing of the target on the radar using an EBL.
- iii. If there is a difference in the two bearings (alignment error), adjust the radar as detailed below.

If the vessel is under way (in reasonably calm conditions):

- i. Align the vessel's bow to the target.
- ii. Note the position of the target relative to the Heading marker.
- iii. If the target is **not** under the Heading marker, there is an alignment error and the radar can be adjusted as detailed below.

- To adjust the radar to eliminate the alignment error:
 1. If a visual relative bearing of a target has been determined, as in 2.1 above, set an EBL to this relative bearing.
 2. Press the **MENU** key to display the setup soft keys and select **RADAR SET UP**.

RADAR SET UP MENU	
EBL DISPLAY	RELATIVE
TIMED TRANSMIT	OFF
TRANSMIT PERIOD	20 SCANS
STANDBY PERIOD	10 MINS
DEFAULT MARK SYMBOL	x
MARK DISPLAY	OFF
CLEAR MARKS	
CUSTOM SCALE	OFF
BEARING ALIGNMENT	<input type="text"/>
ANTENNA SIZE	4 ft
SEND ON HSB	ON

D3649-3

Figure 8-10: Radar Set Up Menu

3. Use the trackpad to move the selection bar on the Radar Set Up Menu to **BEARING ALIGNMENT**.
4. Use the soft keys to adjust the Bearing Alignment slider and to rotate the radar picture. As soon as you start the adjustment, the menu is cleared so that the rotation of the picture can be seen. The keys can be pressed and held, to rotate the picture quickly, rather than in single steps.
5. Rotate the picture to place the target under the EBL, or Heading Marker, depending on the method used to obtain the correct relative bearing.
6. When the bearing alignment error has been eliminated press **ENTER** to re-display the Radar Set Up menu.
7. Press **ENTER** again to return to the set up soft keys, then press **CLEAR** to return to the normal radar screen.
8. After adjusting the radar, always check the bearing alignment at the next opportunity. Usually the bow alignment to target is the most convenient method (see *If the vessel is under way (in reasonably calm conditions)*: on page 8-18).

Display Timing Adjustment

The display timing can be affected by the length of the cable used to connect the scanner to the display unit. This in turn affects the short range accuracy shown on the display. If you have extended (or reduced) your inter-unit cable, you will need to check the display timing before using the system for navigation.

Incorrect timing is most noticeable on the $\frac{1}{8}$ nm or $\frac{1}{4}$ nm range scales. Targets such as bridges or piers appear bent or bowed.

Note: Under normal circumstances you do not need to adjust these settings, as they are set automatically at the factory. **If these parameters are set incorrectly the performance of the radar will be adversely affected.** Access to this menu is therefore via a hidden key press.

- To adjust for correct timing:
 1. Select the $\frac{1}{8}$ nm range.
 2. On the radar locate a straight dock, seawall or bridge that is facing your ship. If the image is bent or bowed, as shown in the following diagram, then you need to adjust the timing.

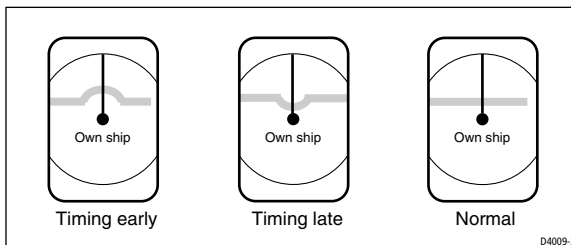

Figure 8-11: Radar Display Timing

3. Press the **MENU** key to display the setup soft keys.
4. Press and hold the blank soft key directly to the right of the RADAR SET UP soft key for 5 seconds. The Advanced Set Up menu is then displayed.
5. Use the trackpad to move the selection bar down to the Display Timing option.
6. Use the soft keys to adjust the Display Timing slider. As soon as you start the adjustment, the menu page is cleared so that you can see the effects of the adjustment on the radar picture, and the radar is set to $\frac{1}{8}$ nm range.
7. When the displayed image appears straight, press **ENTER** to return to the Advanced Set Up soft keys.
8. Press **CLEAR** to return to the setup soft keys, and **CLEAR** again to return to the normal radar screen.

Alternatively, you can use a VRM in conjunction with a target at a known distance and adjust the picture so the target co-incides with the VRM.

EMC Conformance

Always check the installation before going to sea to make sure that it is not affected by radio transmissions, engine starting etc.

8.8 Integrated Systems

The *hsb²* series displays can be linked to other equipment to transfer data as follows:

- Additional displays, either CRT or LCD, can be connected via *hsb²* (and SeaTalk) to repeat fishfinder, chart and/or radar information at a remote location.
- Data can be received via SeaTalk or NMEA, some of which will increase the functionality of the display. Other data can be viewed on the display.
- Data can be transmitted via SeaTalk and NMEA to enhance other equipment.
- Some incoming data can be converted across the communication link and re-transmitted - see *Data Conversion* on page 8-30.

Power for External Equipment

External equipment cannot be powered from the display's SeaTalk interface. It must be powered from the ship's supply or via a SeaTalk bus. Ensure correct polarity of the SeaTalk connection.

For systems where the ship's power source is 24 V only, you may need to install a 24 V to 12 V DC converter. This is only necessary if the products being connected to the display are:

- SeaTalk compatible (for example, compass, GPS and instruments), and there is no existing SeaTalk bus
- NMEA compatible, but operate only from 12 V (for example, compass, GPS and some navigators)

The DC~DC converter must conform to the following specification:

Table 8-2: DC-DC Converter for External Equipment

Input	21 to 32 V DC
Output	13.6 V DC, isolated
Load	Continuous current rating, in excess of required load

*hsb²*TM (High Speed Bus) Multiple Display Systems

You can connect several *hsb²* displays; the number is dependent on cable length - see *hsb² Cable* on page 8-9. The system can include existing HSB display units that have been suitably upgraded - contact your authorized Raymarine dealer for upgrade kit details.

The High Speed Bus (*hsb²*) provides extremely rapid transfer of data between master and repeater displays. With an *hsb²* and a SeaTalk connection most data available can be controlled and displayed by any *hsb²* unit in the system. (Guard zones cannot be viewed or controlled on the chartplotter display, nor on a repeater display that is not directly connected to a scanner. Likewise, radar timed transmission is not available on a repeater display).

Master functionality is provided by the display with the appropriate transducer connected as defined in *Table 8-3*.

Table 8-3: *hsb²* Series Master Displays

Master Function	Display type	Transducer
Radar	R70/RCPLUS, RL70/C/RC/CRC PLUS R80/RC PLUS, RL80/C/RC/CRC PLUS	Any Pathfinder PLUS Series Scanner
Chart	RC520PLUS, RC530PLUS, RC631PLUS R70RC PLUS, R80RC PLUS RL70RC/CRC PLUS, RL80RC/CRC PLUS L755RC PLUS, L760/RC PLUS, L1250/RC	Display includes a two-slot chart cartridge
Fishfinder	L755RC PLUS, L760/RC PLUS, L1250/RC	Fishfinder transducer

Any combination of *hsb²* series displays is possible – each display could provide different master functionality. Each display repeats the master functionality of the other displays.

For example, you could connect an *hsb²* Radar display and an *hsb²* Fishfinder display (which provides both fishfinder and chart functions), to enable you to display and control radar, fishfinder and chart data on either or both displays. You can display some combinations, such as radar/chart, in half-screen windows.

hsb² Connection

Each *hsb²* display is supplied with an in-line terminator fitted to the HSB socket. When connecting two displays via *hsb²*, plug the cable into the in-line terminator on both displays.

When connecting more than two displays via *hsb²* you must fit an *hsb²* splitter to at least one HSB socket. The splitter is fitted only to displays that are *not at the end of the chain*, and when installing the splitter you must remove the in-line terminator. *Figure 8-12* illustrates the use of splitters and in-line terminators in a multi-display system.

The displays must also be connected via SeaTalk (see *SeaTalk® and NMEA In* on page 8-24

Note: The *hsb²* cables have ferrite clamps attached at each end to ensure EMC conformance. The cables are available in lengths of 1, 3, 6, 10 and 20 m.

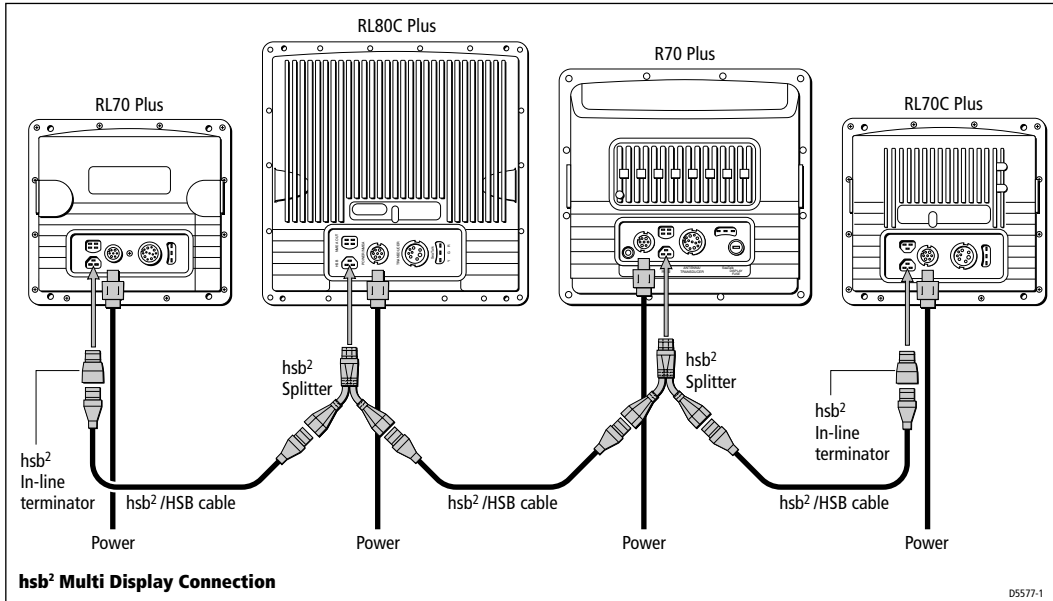

Figure 8-12: Multi-display connections

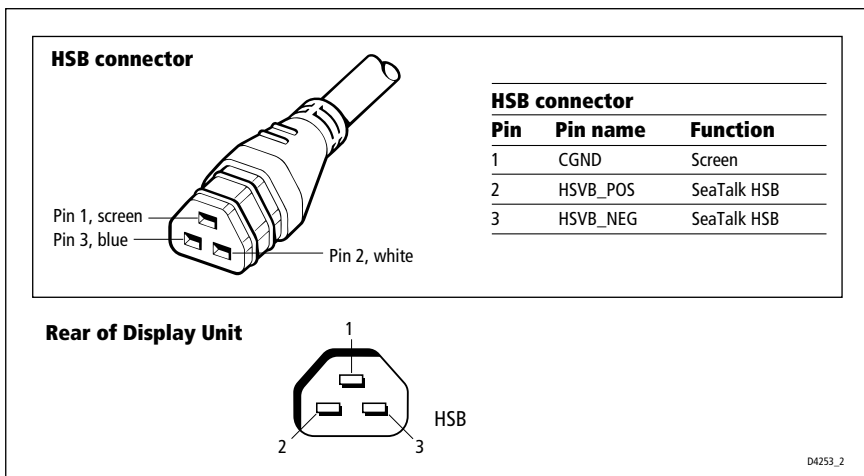

Figure 8-13: *hsb²* Connector

hsb²™ (High Speed Bus) Multiple Display Systems

SeaTalk® and NMEA In

The *hsb²* series display can receive a comprehensive range of data. The primary data is described below:

Table 8-4: Function of SeaTalk and NMEA Data

Data	Primary Uses	Suggested Source
Heading	Heading Modes MOB (if Speed data also available) Radar/Chart Overlay (chart), MARPA (radar)	Autopilot, Compass connected to SeaTalk bus NMEA Compass*
Position	MOB (also requires speed and HDG data) Radar/Chart Overlay Position data in data box and Nav Window Waypoints & Marks Own vessel position (chart) Data Log (chart)	SeaTalk GPS connected via Auxiliary JB Existing GPS Navigator via SeaTalk bus Existing GPS (or Loran-C) navigator with NMEA output
Waypoint	Chart: Waypoint and route transfer	Existing GPS Navigator via SeaTalk bus Existing GPS (or Loran-C) navigator with NMEA output

*Accurate heading data is required for MARPA and radar/chart overlay, and it must be provided on NMEA. We recommend the Raymarine Rate Gyro Compass or a Raymarine autopilot system incorporating a 150G or 400G Course Computer with internal rate gyro.

Heading data should ideally contain both magnetic and true heading. If only one is available then variation needs to be provided either manually or automatically - see *Variation Source* on page 7-8.

Some other radars and chartplotters can exchange their cursors via SeaTalk.

Locked heading should be used for Course Up if available via SeaTalk.

Other data connected via a SeaTalk bus or via NMEA is generally displayed in data boxes, e.g. depth, apparent wind angle and speed, time.

Note: *The Fishfinder uses its own depth data, rather than any other depth data on SeaTalk. If there is no other depth data on SeaTalk, Fishfinder depth is transmitted. If speed and temperature data are available on SeaTalk the Fishfinder uses this data; if this data is not on SeaTalk from other instruments, it is transmitted by the Fishfinder.*

For details of received data refer to the table in *Appendix D: SeaTalk and NMEA Data Received and Transmitted*. Examples of SeaTalk and NMEA systems are shown in *Figure 8-14* and *Figure 8-15*.

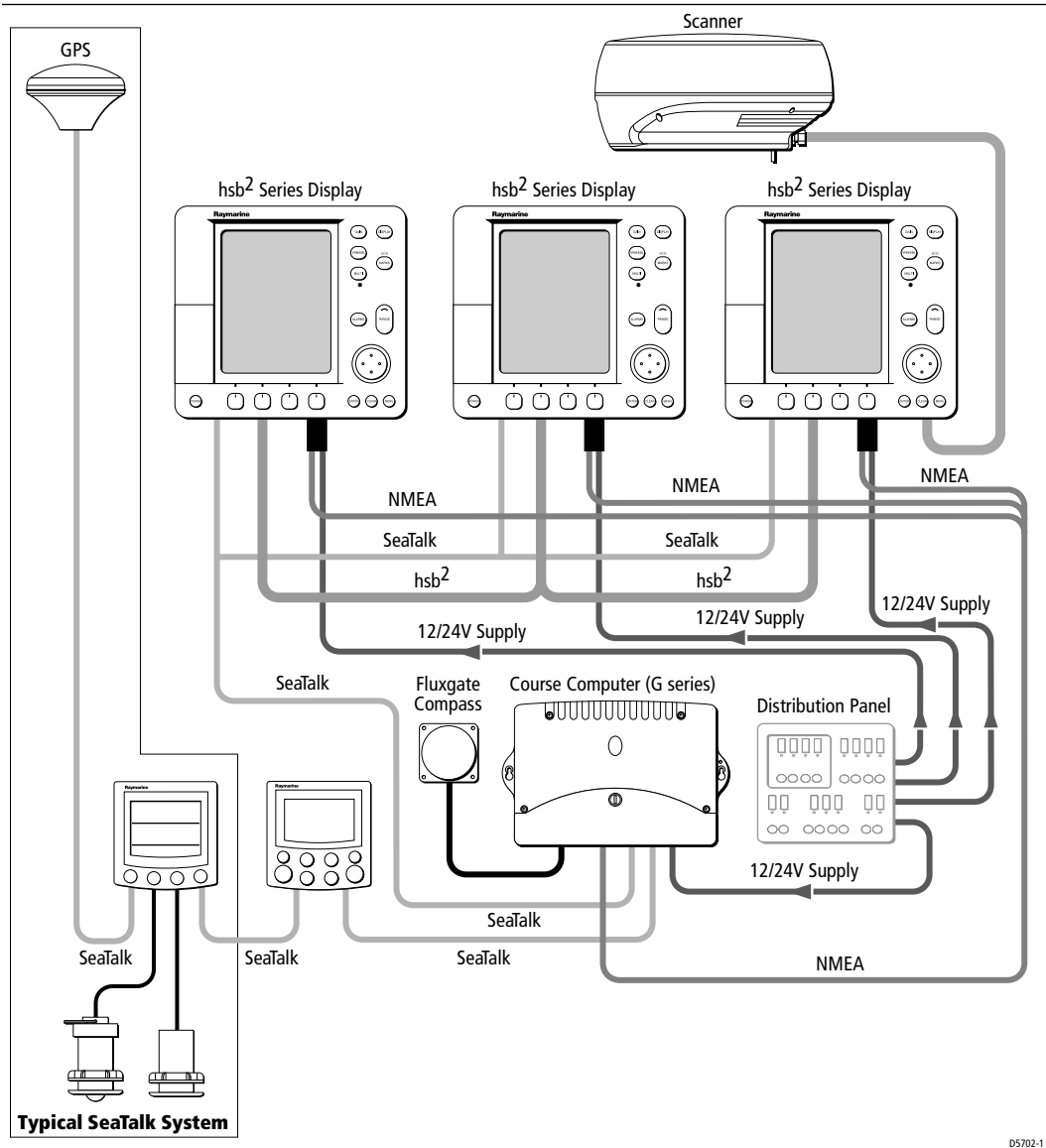

Figure 8-14: Integrated System with Repeater Display and SeaTalk Instruments

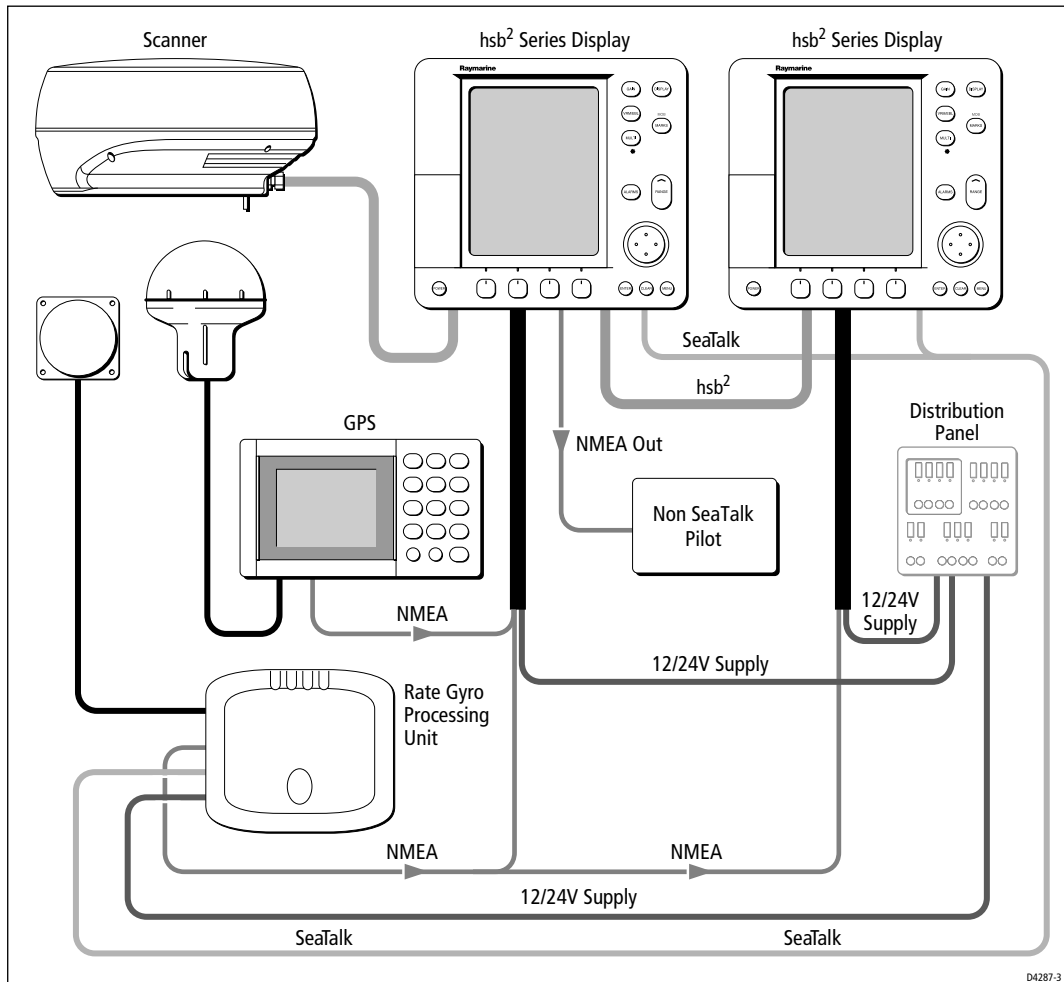

Figure 8-15: Integrated System with Repeater Display and NMEA Instruments

SeaTalk

The SeaTalk standard was originally developed by Autohelm (part of Raymarine), and allows compatible instruments to be connected by a single cable carrying power and data in/out. This means that additional instruments and functions can be added to a SeaTalk system, simply by plugging them into the network.

SeaTalk is a precise, high-speed, bi-directional protocol which is flexible enough to adapt to any number of instruments, without a central processor. SeaTalk equipment can also communicate with non-SeaTalk equipment via the NMEA standard.

SeaTalk Connection

This connection is necessary for full functionality between *hsb²* series displays. SeaTalk data, if present, is the primary source for all navigational data except heading.

The SeaTalk input/output should be connected at the rear SeaTalk 3-pin connector. This appears as follows, when viewed from outside:

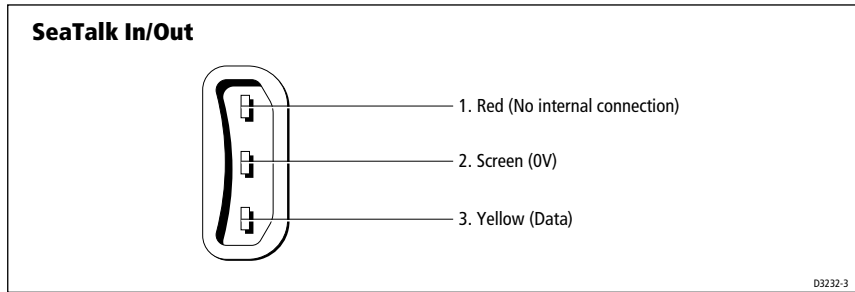

Figure 8-16: SeaTalk Connector

Table 8-5: Sea Talk Connections

Pin No.	Function	Color
1	+12 V	Red
2	0 V	Shield
3	Data	Yellow

Note:

1. If you use the SeaTalk connector you must fit the supplied ferrite to the cable for EMC CE conformance. The ferrite must be clipped to the cable as close to the connector as possible.
2. The display does not supply 12 V via the SeaTalk connector, neither does the SeaTalk connector require 12 V to operate. 12 V is required for other SeaTalk units (except where SeaTalk is connected only between two *hsb²* displays).
3. If you are connecting an active compass to the radar, the NMEA input has priority. You should, therefore use an NMEA input channel (see Power and NMEA Input Connection) rather than the SeaTalk interface, unless the compass only has a SeaTalk output.

To connect the display unit to the SeaTalk bus, connect a standard SeaTalk cable between the SeaTalk connector on the rear of the display and a SeaTalk instrument or the SeaTalk bus. For multi-display systems, use a SeaTalk Junction 3-way block (part number D244) at each display.

Standard SeaTalk cables are available in a range of lengths (part numbers W284 to W287), and cables for connecting to SeaTalk units with round connectors are also available (part numbers D187 or D188), see Section 8.2 for further details.

NMEA 0183

The NMEA 0183 Data Interface Standard was developed by the National Marine Electronics Association of America. It is an international standard that enables equipment from many different manufacturers to be connected together and to share information.

The information is passed in “sentences”, each of which has a three-letter sentence identifier. When you check to see if one item will “talk” to another, make sure that the two items both use the same sentence identifiers. For example: VTG carries Course and Speed Over Ground data; GLL carries latitude and longitude; DBT carries water depth; MWV carries relative wind angle and wind speed data.

The NMEA 0183 standard carries similar information to SeaTalk. However, it has the important difference that one cable will only carry information in one direction. For this reason NMEA 0183 is generally used to connect a data receiver and a transmitter together: for example, a compass sensor transmitting heading to a radar, or a GPS sensor (or Chartplotter) transmitting position and navigation data to a radar.

NMEA Input Connection

The two NMEA/Power input connectors are normally used for non-SeaTalk Compass (heading) data or GPS. It can also be used for additional navigation data (if not provided via SeaTalk).

Connect the input(s) to the orange and yellow wires (Channel 1) and/or the green and blue wires (Channel 2). Refer to *Power and NMEA Input Connection* on page 8-15 for further details.

For example, to connect a Raymarine Heading Sensor to the NMEA Channel 1 input, connect the cables and power supply using a suitable connector block, as shown in the diagram below. If installed, it may be convenient to connect the power to the SeaTalk auxiliary junction box described in the following section.

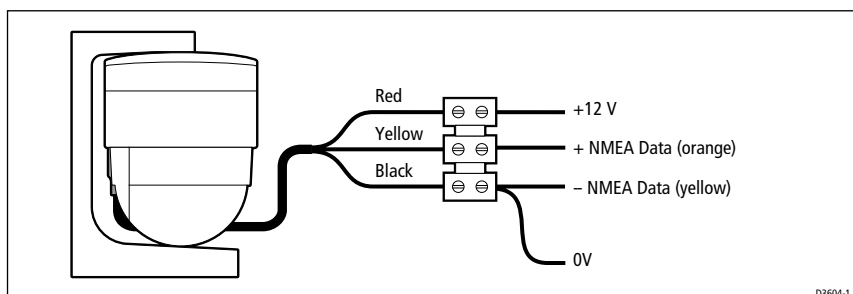

Figure 8-17: NMEA Input Connection

Using the SeaTalk Auxiliary Junction Box

A junction box (provided with the radar/chart and chart displays; optional with the radar displays) is used to connect the SeaTalk system to the *hsb²* series display unit. This junction box enables the SeaTalk bus, power and GPS to be connected.

If power is not already available (via another SeaTalk instrument), the junction box can be used to apply power to the SeaTalk bus for other applications. The junction box may also be used for other purposes, e.g. supplying power to a flux gate compass and routing the compass data to the *hsb²* series display NMEA In connection, or alternatively, for connecting a NMEA GPS system.

The junction box includes:

- SeaTalk cable and connector to attach to display unit
- Power cable to connect to 12 V power (if required)
- Input connections to connect SeaTalk cable from external equipment
- Spare connections for another instrument

CAUTION:

Ensure correct polarity of the 12 V supply before applying radar or SeaTalk power. It is recommended that a multimeter is used to check the connections.

Figure 8-18 shows how to connect the junction box; *Appendix B* provides connection details for specific GPS and Beacon Receiver systems.

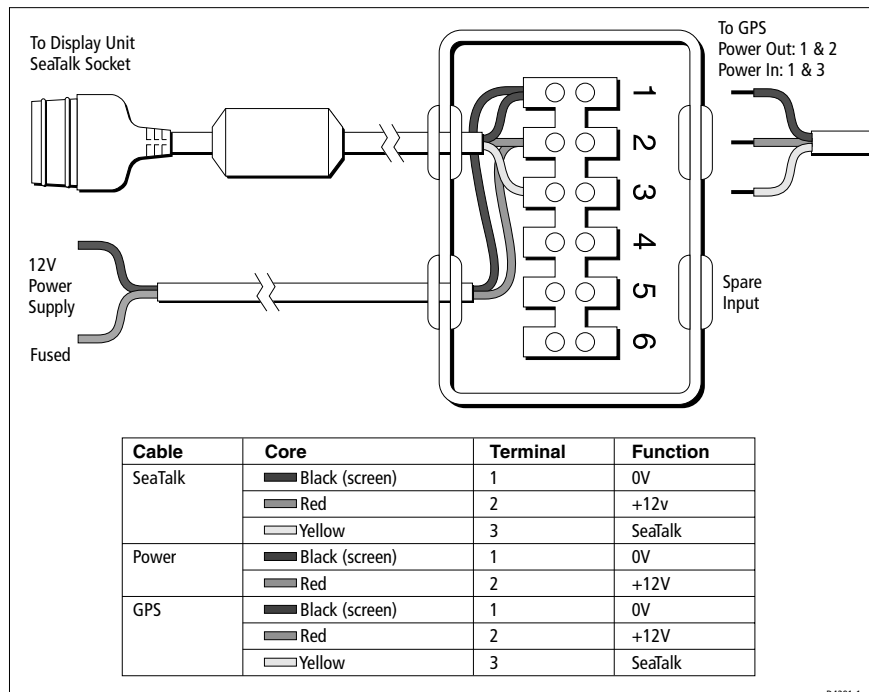

Figure 8-18: Using the Auxiliary Junction Box

Data Output

Data is transmitted in SeaTalk and NMEA formats as detailed in *Appendix D* and can be used to enhance other equipment as required. You can disable the transmission of individual NMEA output sentences - refer to *NMEA Out Set Up* on page 7-9.

The SeaTalk input/output connection is detailed in *SeaTalk Connection* on page 8-27.

The NMEA output connector is a 4-pin connector as illustrated below. The 1.5 m NMEA OUT cable has a ferrite clamp attached to ensure EMC conformance.

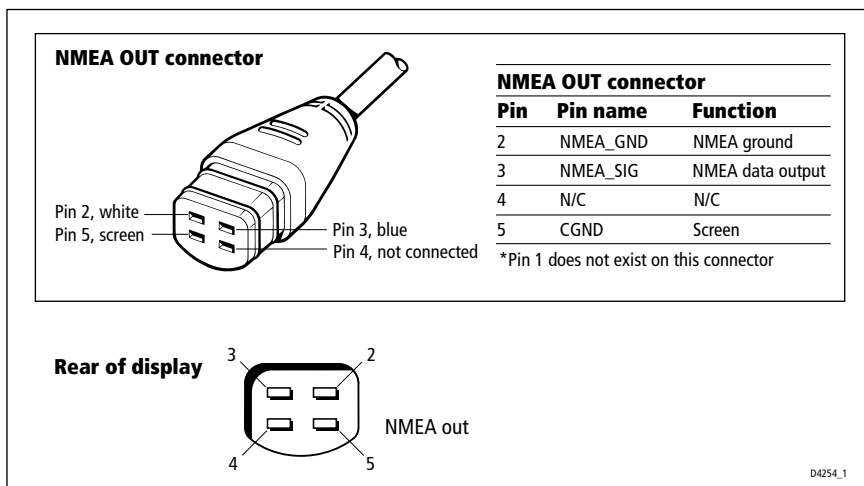

Figure 8-19: NMEA Output Connector

Data Conversion

The *hsb²* series displays convert some information across the communications links as follows:

- NMEA In to NMEA Out and SeaTalk
- SeaTalk to NMEA Out

This enables data received by the display to be passed to other instruments. For example, if you have a master and a repeater display, you only need to connect NMEA In to the master display, which will pass the data to the repeater via SeaTalk.

You can prevent NMEA heading data being bridged onto the Seataalk bus - refer to *Bridge NMEA Heading* on page 7-8.

Note: To transfer NMEA data, or to convert the data, the display must be powered On.

8.9 Integrated System Checks

Chart Display -RL70/80CRC PLUS, RC530 PLUS, RC631 PLUS

When you have connected your display unit to the required equipment ensure that position data is available at the display via NMEA or SeaTalk.

To confirm your chartplotter is operating correctly, perform the following checks:

1. Without a chart card installed, select the Chart display mode and select a suitable range scale. Verify that the world map is visible.
Use the trackpad to check cursor movement and normal scrolling action.
2. To ensure that the display is responding to position data:
Press **FIND SHIP**, check the cursor is fixed on the vessel symbol which is correctly positioned at the center of the chart display.
3. Insert a chart cartridge for the area of your vessel.
Use the **RANGE** key to zoom-in to check that the chart data is being displayed.

Received Data

If either SeaTalk or NMEA In is connected, verify that the expected data is displayed.

1. Press **DISPLAY** and select the NAV DATA WINDOW ON.
Check that the expected data is displayed.
2. If heading data is connected, select Chart mode and check it is displayed in the heading data box, or select Radar mode and check heading is displayed in the Status Bar.

Transmitted Data

If SeaTalk or NMEA Out is being transmitted to other equipment, check that the data is being received correctly.

An NMEA Out connector is used to transmit navigation data. The NMEA Output cable should be connected to the upper, left connector on the rear of the display unit.

Note: *The NMEA Output cable has a ferrite clamp attached to ensure EMC conformance.*

Chapter 9: Maintenance and Problem Solving

This chapter provides information on routine maintenance and on possible causes of problems you may experience with your *hsb²* series display unit.

9.1 Maintenance



WARNING:

The display unit contains *high voltage*. Adjustments require specialized service procedures and tools only available to qualified service technicians - there are no user serviceable parts or adjustments and the operator should not attempt to service the equipment. *The operator should not remove the rear cover of the display.*

Switch off the display unit before removing the power cord.

Routine Checks

The LCD display is a sealed unit. Maintenance procedures are therefore limited to the following periodic checks:

- Examine the cables for signs of damage, such as chafing, cuts or nicks.
- Check that the cable connectors are firmly attached.

Cleaning Instructions

Cleaning the Display

CAUTION:

Take care when cleaning the display. Avoid wiping the display screen with a dry cloth - this could scratch the screen coating.

Do not use acid, ammonia based or abrasive products.

- Ensure power is off, wipe the display clean with a damp cloth.
- If necessary, use IPA (iso-propyl alcohol) or a mild detergent solution to remove grease marks.

EMC Servicing and Safety Guidelines

- Raymarine equipment should be serviced only by authorized Raymarine service technicians. They will ensure that service procedures and replacement parts used will not affect performance. There are no user serviceable parts in any Raymarine product.
- Some products generate high voltages, so never handle the cables/connectors when power is being supplied to the equipment.

- When powered up, all electrical equipment produces electromagnetic fields. These can cause adjacent pieces of electrical equipment to interact with one another, with a consequent adverse effect on operation. In order to minimise these effects and enable you to get the best possible performance from your Raymarine equipment, guidelines are given in the installation instructions, to enable you to ensure minimum interaction between different items of equipment, i.e. ensure optimum Electromagnetic Compatibility (EMC).
- Always report any EMC-related problem to your nearest Raymarine dealer. We use such information to improve our quality standards.
- In some installations, it may not be possible to prevent the equipment from being affected by external influences. In general this will not damage the equipment but it can lead to spurious resetting action, or momentarily may result in faulty operation.

9.2 Resetting the System

There are three types of reset available for the display:

- **Factory Reset:** This resets **all** values back to their original factory settings.

CAUTION:

The factory reset clears the Marks database, and the chartplotter Waypoints and Routes databases.

- **Power-On Reset:** When you turn the display off and on again, the screen reverts to the fishfinder or chart picture with all windows cleared.
- **Picture Reset:** Press and hold the **DISPLAY** key for two seconds to return the screen to the full-screen picture of the top window with all windows cleared.

At power-on, the last-used values are retained for all the options, except for those listed in the following table which are reset to the factory default each time.

Table 9-1: Power On Default Settings

Item	Power-on setting
Heading Mode	Head Up (radar); North Up (chart)
Rain	OFF (but value stored) – radar only
FTC	OFF (but value stored) – radar only
Alarm	ON, with last-used value
Zoom	OFF
Windows	OFF
Brightness	ON at 100%.

➤ To perform a factory reset:

1. Press **MENU**.
2. Press the SYSTEM SET UP soft key to display the System Set Up page (see *Section 7.3* for details).
3. Press and hold **MENU** for 5 seconds.

A countdown timer is displayed. If you release the **MENU** key before the timer reaches zero, the reset is not performed.

When the reset request has been accepted, the system restarts.

The factory default settings are listed in *Section 7.3*

9.3 Problem Solving

All Raymarine products are, prior to packing and shipping, subjected to comprehensive test and quality assurance programs. However, if this unit should develop a fault, please refer to the following table to identify the most likely cause and the corrective action required to restore normal operation.

If you still have a problem after referring to the table below, contact your local dealer, national distributor or Raymarine Technical Services Department for further advice.

Always quote the product serial numbers. The display unit serial number is printed on the back of the unit.

Common Problems and Their Solutions

Table 9-2: Common Problems

Problem	Correction
Display does not function	1. Make sure that the power supply cable is sound and that all connections are tight and free from corrosion. 2. Check the system fuse.
"Scanner not responding" message	Check that the cable connecting the scanner to the radar display unit is firmly attached and undamaged.
The bearing displayed on the radar display is not the same as the actual bearing.	Perform the bearing alignment procedure described in

Technical Support:

Please visit our website at:

www.raymarine.com/recreational/support

where you will find a Questions & Answers database, service information and e-mail access to the Technical Support department.

Alternatively, if you don't have access to the world wide web, call:

1-800-539-5539 extension 2444 or
(603) 881-5200 extension 2444

Our Technical Support Specialists are available to answer questions about installing, operating and trouble-shooting all Raymarine products.

How to Contact Raymarine (US)

For Marine Product and Services Information

Visit the Raymarine World Wide Web site for the latest information on the newest Raymarine electronic equipment and systems at:

www.raymarine.com

For Accessories and Parts

Many Raymarine accessory items and parts can be obtained directly from your authorized Raymarine dealer. However, if you are in need of an item not available from the retailer, please contact Raymarine Technical Services at:

1-800-539-5539 extension 2333 or (603) -881-5200.

Technical Service is available Monday through Friday 8:15 AM to 5:00 PM Eastern Standard Time.

Please have the Raymarine item or part number ready when calling if placing an order. If you are not sure which item is appropriate for your unit, you should first contact the Technical Support Department at:

1-800-539-5539 ext. 2444 or
(603)-881-5200 to verify your requirements.

For Product Repair and Service

In the unlikely event your Raymarine unit should develop a problem, please contact your authorized Raymarine dealer for assistance. The dealer is best equipped to handle your service requirements and can offer timesaving help in getting the equipment back into normal operation.

In the event that repairs can not be obtained conveniently, product service may also be obtained by returning the unit to:

Raymarine Product Repair Center
22 Cotton Road, Unit D
Nashua, NH 03063-4219

The Product Repair Center is open Monday through Friday 8:15 a.m. to 5:00 p.m. Eastern Standard Time or Eastern Daylight Savings Time. All products returned to the Repair Center are registered upon receipt. A confirmation letter will be sent to you acknowledging the repair status and the product's reference number. Should you wish to inquire about the repair status of your unit, contact the Product Repair Center at:

1-800-539-5539

Please have the product reference number, or unit serial number, ready when you call. We will do everything possible to make the repair and return your unit as quickly as possible.

How to Contact Raymarine (Europe)

In Europe, Raymarine support, service and accessories may be obtained from your authorised dealer, or contact:

Raymarine Company
Anchorage Park, Portsmouth
PO3 5TD, England
Tel +44 (0)23 9269 3611
Fax +44 (0)23 9269 4642

Or visit the Raymarine World Wide Web site:

www.raymarine.com

Accessories and Parts

Raymarine accessory items and parts are available through your authorized Raymarine dealer. Please refer to the lists of component part numbers and optional accessories in the Installation chapter of this manual, and have the Raymarine part number ready when speaking with your dealer.

If you are uncertain about what item to choose for your Raymarine unit, please contact our Customer Services Department prior to placing your order.

Worldwide Support

Please contact the authorized distributor in the country. A list of worldwide distributors is supplied with your system.

Appendix A: Specification

hsb² Series 7" and 10.4" LCD Color Displays

General

Approvals:		
CE - conform to		1999/5/EC, EN60945:1997
FCC - conforms to		Part 80 (47CFR) and Part 2 (47CFR)
Size:	7"	223 x 205 x 152 mm (8.8" x 8.1" x 6"), excluding bracket
	10.4"	292 x 289 x 139 mm (11.5" x 11.4" x 5.46") excluding bracket
Weight		1.2 kg(2.6lbs)
Mounting		Bracket with panel mount option
Power		External 10.7 - 44 V DC required Floating earth/fully isolated
	7"	20 Wmax. consumption with full brightness
	10.4"	30 W max. consumption with full brightness
Environmental:		Waterproof to CFR46; suitable for external mounting
Operating/Storage Temp. Range		-10°C to +50°C
Humidity limit		up to 95% at 35°C non-condensing
Controls		11 defined keys, 4 soft keys and trackpad
Cursor		Context sensitive, provides range/bearing or lat/lon
Display Type:		color TFT LCD
Resolution:		640 x 480
Display Size	7"	136 mm x 100 mm
	10.4"	211 mm x 154.4 mm
Illumination		Screen: 8 levels of backlighting Keypad: 3 levels of backlighting
Day/Night Mode		Day and Night color palettes available
Languages		UK English, US English, Danish, French, German, Dutch, Italian, Icelandic, Norwegian, Portuguese, Spanish, Swedish, Finnish
Connectors		13 pin scanner 3 pin <i>hsb²</i> input/output 3 pin SeaTalk input/output 7 pin power including 2 NMEA input channels 4 pin NMEA output
Interfaces		1 x SeaTalk, receive and transmit 1 x <i>hsb²</i> , receive and transmit 2 x NMEA 0183, receive 1 x NMEA 0183, transmit C-MAP cartridge reader - 2 slots

Cursor Echo	Cursor Echo between radar and chart on split screen and/or separate displays connected via SeaTalk.
Man Overboard (MOB Mode)	Mark placed with course line; readout shows range, bearing, lat/lon of MOB and time elapsed since MOB.
Screen Functions	Full, half and quarter screens available dependent on function
Radar/Chart Overlay	Radar image can be overlaid on full-screen chart
Data Boxes	Up to six user selectable information boxes

Radar Features

Range Scales (Range Rings)	0.125 (0.0625), 0.25 (0.125), 0.5 (0.125), 0.75 (0.25), 1.5 (0.25), 3 (0.5), 6 (1), 12 (2), 24 (4), 48 (8) or 72 (12) nm selectable (dependent on scanner). Performance limited by the scanner type and position. Range scales can be customized
Range Ring Accuracy	Better than +/- 1.5% of the max. range scale in use, or 22 m (72 ft.), whichever is the greatest.
Bearing Accuracy	+/- 1°
Variable Range Markers	2xVRMs, readout nm, kyds, sm, km
Electronic Bearing Lines	2xEBLs, floating if required, resolution 1°
Bearing Scale	360° graduated at 10° intervals
Minimum Range	23 m (25 yds)
Range Discrimination	23 m (25 yds)
Presentation Modes	Head up, Course up or North up (selectable True or Magnetic) Relative or True Motion
Scanner Control	Interference rejection, standby/transmit modes, pulse selection, Tune, Rain, FTC, and Sea controls, with selection of manual or automatic control of gain, sea clutter and tune (Auto GST™)
Magnetic Sensor	NMEA or Seataalk
Waypoint Navigation	Lollipop symbol, WPT range, bearing, TTG or lat/lon readout
Marks	100 Mark database
MARPA	Manual acquisition of 10 targets, automatic tracking, dangerous target alarms, safe zone, target history, true or relative vectors
Variation Source	Auto (SeaTalk/NMEA/Internal algorithm) or Manual
Guard Zone Alarm	2 guard zones, selectable sensitivity level, audible alarm
Radar/Chart Synchronization	User selectable in split screen mode provided chart data available

Zoom Mode	x2, from 0.25 nm to maximum range, in 1/4 window and full screen from 1/4 window.
Off Centre Function	66% of radius (except maximum range)
Display Windows	Radar, Chart, CDI, BDI and Navdata
Wakes	Short, medium, long, off
Target Expansion	Operator selectable (0.5 nm to 3 nm ranges only)
Timed TX	Rotation periods: 10, 20 or 30 scans Repetition periods: 3, 5, 10 or 15 minutes

Chartplotter Features

Cartography	C-MAP® NT micro cartridges available from C-MAP® Chart of the world built in
Display Windows	Chart, Radar, Data Log, BDI, CDI, Navdata
Chart Scaling	1/64 nm (if cartographic data is available) to 4000 nm
Presentation Modes	North up (selectable True or Magnetic) Head up or Course up
Waypoints	1000 waypoints entered via cursor, lat/lon, range and bearing from present position or at vessels position. 16 character name can be assigned Additional storage available on User Cartridges
Waypoint Transfer	<i>hsb²</i> , current route via Seataalk, NMEA
Routes	A route plan may contain up to 50 waypoints. Up to 20 routes can be stored in the units internal memory Additional storage available on User Cartridges
Track History	5 tracks with up to 750 points in each can be stored in the units internal memory Additional storage available on User Cartridges
Alarms	Programmable arrival, cross track error, anchor drift, position fix/data loss warning, countdown timer and alarm clock
Navigation Information	Own ships position in Lat/Lon, XTE, TTG and SOG/COG selectable. Mileage scale ruler. Bearing and distance to waypoint. Bearing and distance to cursor, SeaTalk data (see 'interfacing' section)
Variation Source	Auto (SeaTalk/NMEA/Internal algorithm) or Manual
Chart/Radar Synchronization	User selectable in split screen mode provided radar/chart data available

Interfacing

High Speed Bus	Fully independent use of remote Chart data if present on <i>hsb²</i> . Full remote control and display of Radar data if present on <i>hsb²</i>
SeaTalk Input	Depth, Speed Over Ground & Course Over Ground, Position, Waypoint number, range, bearing and time to go, Speed through water, Time, Cross Track Error, Heading, Wind, Date, Log/Trip, Pilot Status, Temperature, Man Overboard, and cursor position
NMEA Input	NMEA 0183 (GLL, GGA, GLC, GTD, VTG, BWC, BWR, RMA, RMB, RMC, XTE, VHW, HDG, HDM, HDT, DBT, DPT, APB, VLW, MWV, MTW, WPL, RTE and ZDA)
SeaTalk Output	Cursor data, Guard zone alarm and Navigational data bridged from NMEA1
NMEA Output (User selectable)	APB, BWC, BWR, DBT, DPT, GGA, GLL, MTW, RMA, RMB, RMC, RSD, TTM, VLW, VHW, VTG, WPL, ZDA

Appendix B: Using the Auxiliary Junction Box

The SeaTalk Auxiliary Junction Box is used to connect SeaTalk GPS and Differential beacon receivers to your *hsb²* series display.

Note: *With the exception of the Raystar 114, when you use the following Differential Beacon Receiver configurations, the receiver must be set to AUTO MODE in the GPS Set-Up page. Manual selections will not be accepted. Refer to Chapter 6 for details.*

The recommended method of providing position, course over ground and speed over ground information to the *hsb²* displays is by connection to a SeaTalk GPS. The *hsb²* series chartplotter displays are supplied with an Auxiliary Junction Box, whose main purpose is to make this connection easier. The junction box has two flying leads, one with a SeaTalk plug for connection to the display and the other lead is for connection to a 12V power supply (the display does **not** provide power for the GPS).

The following sections detail the connections to the Auxiliary Junction Box for several different types of GPS, including a beacon receiver if installed. Except for Raystar 114, the differential beacon receivers used are Raymarine NRD-2A, Apelco BR101 and the Autohelm Beacon Receiver.

The connections detailed in the following sections ensure that the GPS will always operate in SeaTalk mode. Note that the Raystar 112LP must be the SeaTalk version.

Raystar 112, 105,
Apelco 182 and
182XT

Raystar 112, 105, Apelco 182 and 182XT

In order to connect your GPS to your *hsb²* display, you must first cut off the 6-pin connector and strip back the insulation on all the wires. Connect to the Auxiliary Junction Box as shown in the first illustration below.

To connect your Differential Beacon Receiver, you must cut off the 5-pin connector (Raytheon and Apelco versions), strip back the insulation on all the wires and connect to the Auxiliary Junction Box as shown in the second illustration below.

CAUTION:

Ensure the correct polarity of the 12 V supply before applying display or SeaTalk power. It is recommended that a multimeter is used to check the connections.

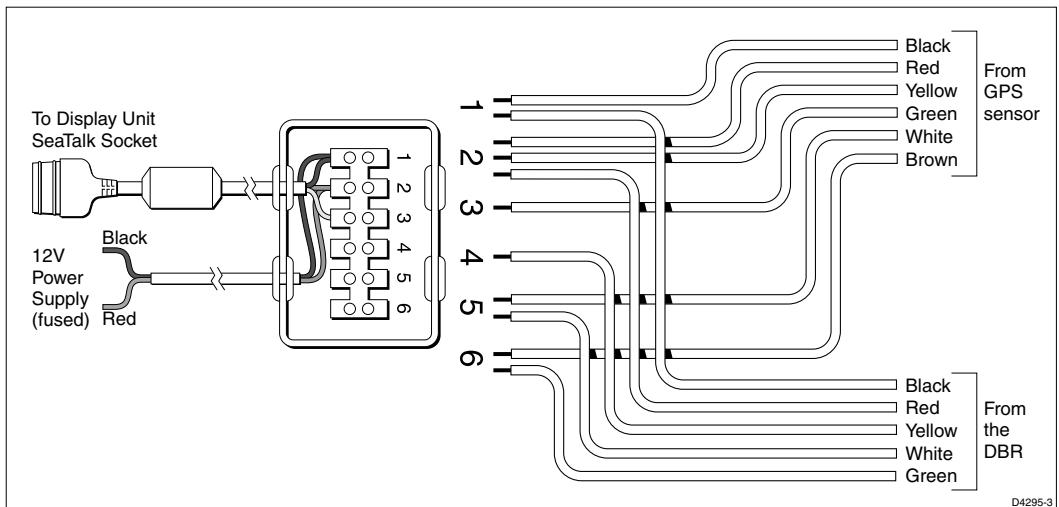
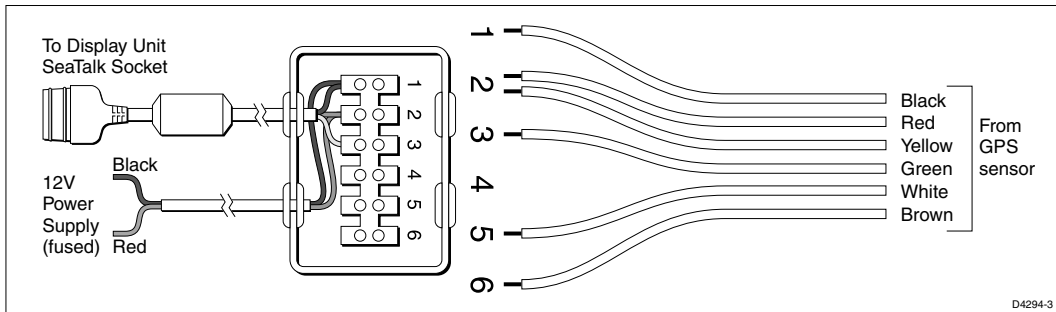

Autohelm GPS, Z260 and Z273

To connect your GPS to your *hsb²* display connect the wires as shown in the first illustration below.

To connect your Differential Beacon Receiver, you must cut off the 5-pin connector (Raytheon and Apelco versions) strip back the insulation on all the wires and connect to the Auxiliary Junction Box as shown in the second illustration below.

CAUTION:

Ensure the correct polarity of the 12 V supply before applying display or SeaTalk power. It is recommended that a multimeter is used to check the connections.

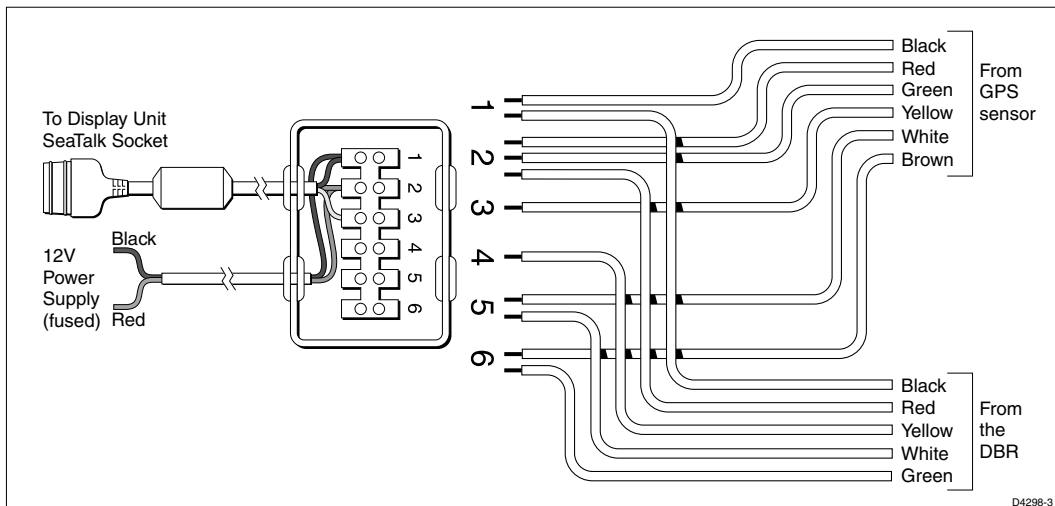
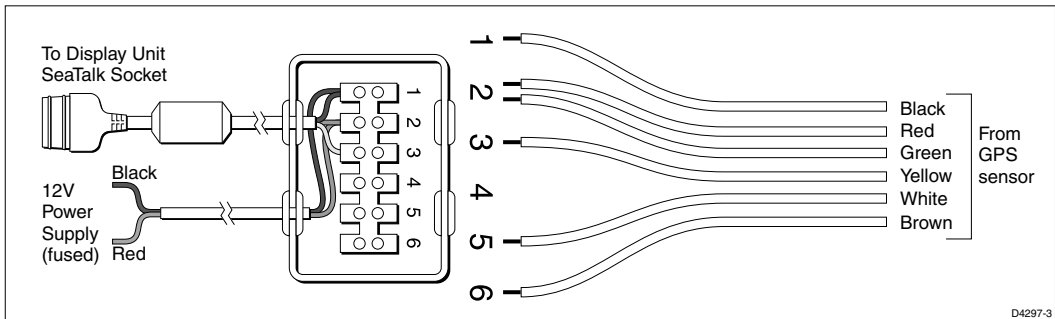

Raystar 112, 105,
Apelco 182 and
182XT

Raystar 112, 105,
Apelco 182 and
182XT

Raystar 112LP (SeaTalk version)

To connect your Raystar 112LP to your *hsb²* display, refer to the first illustration below or follow the instructions in *Chapter 8*.

To connect the Raystar 112LP and your Differential Beacon Receiver, cut off the 5-pin connector and strip back the red, black and green wires. Remove the sleeve from the end of the Raystar 112LP cable to expose the green and brown wires, then connect to the Auxiliary Junction Box as shown in the second illustration below.

CAUTION:

Ensure the correct polarity of the 12 V supply before applying display or SeaTalk power. It is recommended that a multimeter is used to check the connections.

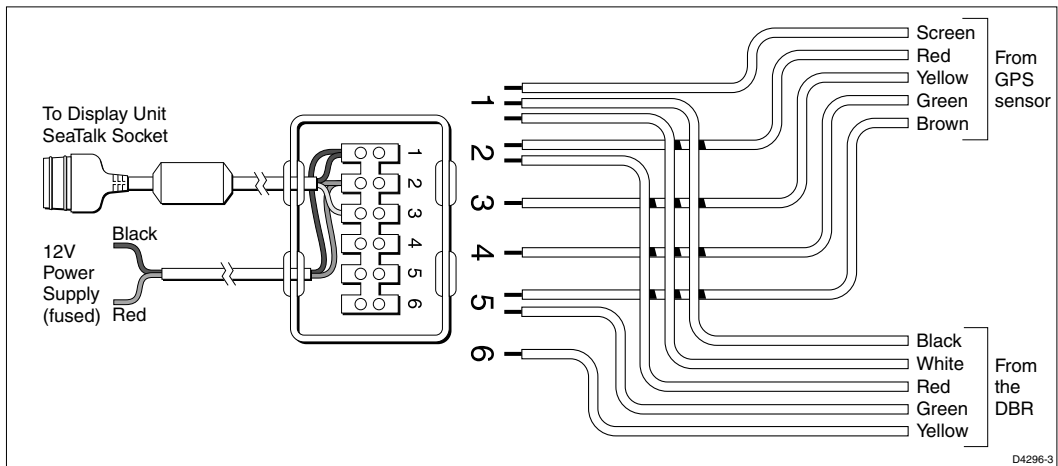
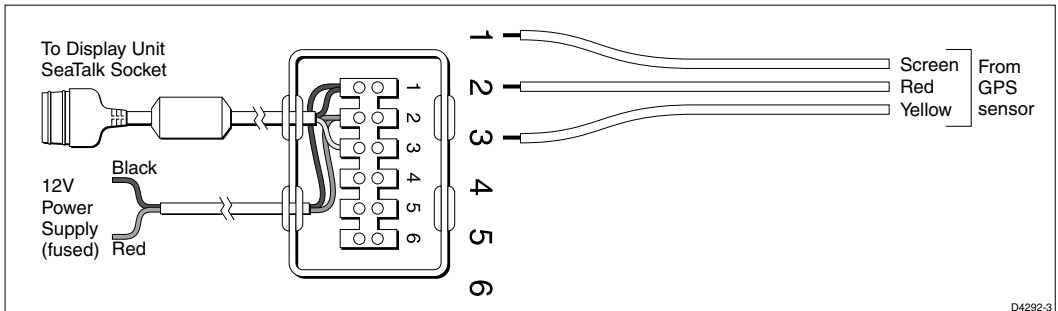

Raystar 114 Combined GPS and Differential Beacon Receiver

To connect your Raystar 114 Combined GPS and Differential Beacon Receiver to your *hst²* display, cut off the 5-pin connector, strip back the insulation on all the wires and connect to the Auxiliary Junction Box as shown in the illustration below.

CAUTION:

Ensure the correct polarity of the 12 V supply before applying display or SeaTalk power. It is recommended that a multimeter is used to check the connections.

Note: *You can use the GPS Set-Up page to manually tune the Raystar 114. Refer to Chapter 6 for details.*

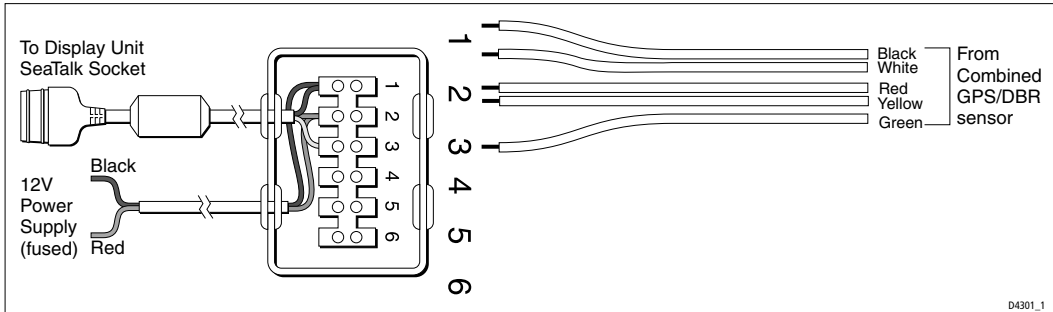

Raystar 112, 105,
Apelco 182 and
182XT

Raystar 120 WAAS Satellite Differential Receiver

To connect your Raystar 120 WAAS Satellite Differential Receiver to your *hsb²* display, connect to the Auxiliary Junction Box as shown in the illustration below. Optional connections to RTCM are also shown. Note that the green wire is not used.

CAUTION:

Ensure the correct polarity of the 12 V supply before applying display or SeaTalk power. It is recommended that a multimeter is used to check the connections.

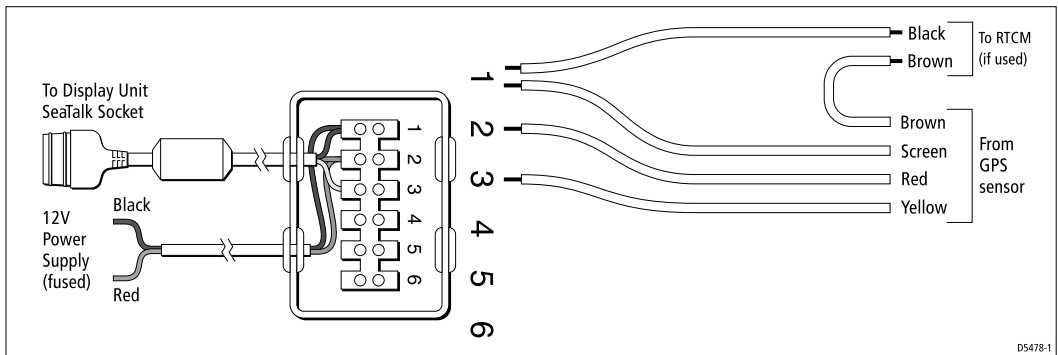

Appendix C: C-MAP Chart Card Features

The C_MAP chart cards display cartographic features which are derived from a library of symbols. The library includes a set of 16 x 16 pixel bitmaps which provide realistically shaped icons for many chart objects. However, these complex icons can overlap and clutter the display at some scales, so it possible for the user to select smaller, simple icons. Some chart objects are represented by text; in such cases conventional abbreviated text is used, for example, M – mud, R – rock, Wk – wreck

The chartplotter set up menu provides the sub-menu CUSTOMISE CHART, which lets you determine how chart features are displayed. You can set the icon display of many features to custom; you then use the CUSTOM soft key to switch the customized icons off/on. The factory default for the CUSTOM options is on.

The chart features controlled from the Customize Chart menu are grouped as detailed below, some groups are sub-divided into categories

Menu Option	Chart Features																																										
CHART TEXT	Names																																										
CHART BOUNDARIES	Chart Boundaries																																										
SPOT SOUNDINGS	Spot Soundings																																										
DEPTH SHADING LIMIT	Reference Depth																																										
DEPTH CONTOURS	Depths (Bathymetric Lines) Depth Labels																																										
DEPTH CONTOUR DISPLAY	Depth Contour Range																																										
NAV MARKS	<table border="0"> <tr> <td>Lights:</td> <td>Buoys and Beacons:</td> <td>Signals</td> </tr> <tr> <td>Light;</td> <td>Buoy, cardinal</td> <td>Anchor</td> </tr> <tr> <td>Light moire' effect;</td> <td>Buoy, installation</td> <td>Cairn</td> </tr> <tr> <td>Light float;</td> <td>Buoy, isolated danger</td> <td>Chain/Wire</td> </tr> <tr> <td>Light vessel</td> <td>Buoy, lateral</td> <td>Fog signal</td> </tr> <tr> <td></td> <td>Buoy, safe water</td> <td>Radar reflector</td> </tr> <tr> <td></td> <td>Buoy, special purpose</td> <td>Top mark</td> </tr> <tr> <td></td> <td>Buoy, generic</td> <td>Nav aid, generic</td> </tr> <tr> <td></td> <td>Beacon, cardinal</td> <td>Extended nav- aid,</td> </tr> <tr> <td></td> <td>Beacon, isolated danger</td> <td>generic</td> </tr> <tr> <td></td> <td>Beacon, lateral</td> <td>Radar station</td> </tr> <tr> <td></td> <td>Beacon, safe water</td> <td>Radar transponder beacon</td> </tr> <tr> <td></td> <td>Beacon, special purpose</td> <td>Radio station</td> </tr> <tr> <td></td> <td>Beacon, generic</td> <td></td> </tr> </table>	Lights:	Buoys and Beacons:	Signals	Light;	Buoy, cardinal	Anchor	Light moire' effect;	Buoy, installation	Cairn	Light float;	Buoy, isolated danger	Chain/Wire	Light vessel	Buoy, lateral	Fog signal		Buoy, safe water	Radar reflector		Buoy, special purpose	Top mark		Buoy, generic	Nav aid, generic		Beacon, cardinal	Extended nav- aid,		Beacon, isolated danger	generic		Beacon, lateral	Radar station		Beacon, safe water	Radar transponder beacon		Beacon, special purpose	Radio station		Beacon, generic	
Lights:	Buoys and Beacons:	Signals																																									
Light;	Buoy, cardinal	Anchor																																									
Light moire' effect;	Buoy, installation	Cairn																																									
Light float;	Buoy, isolated danger	Chain/Wire																																									
Light vessel	Buoy, lateral	Fog signal																																									
	Buoy, safe water	Radar reflector																																									
	Buoy, special purpose	Top mark																																									
	Buoy, generic	Nav aid, generic																																									
	Beacon, cardinal	Extended nav- aid,																																									
	Beacon, isolated danger	generic																																									
	Beacon, lateral	Radar station																																									
	Beacon, safe water	Radar transponder beacon																																									
	Beacon, special purpose	Radio station																																									
	Beacon, generic																																										
LIGHT SECTORS	Light Sectors																																										

Menu Option	Chart Features	
CAUTION & ROUTING DATA	Caution Areas	Tracks and Routes
	Caution area	Deep water route part
	Fishing facility	Deep water route centerline
	Marine farm/culture	Fairway
	Cable, submarine	Ferry route
	Cable area	Navigation line
	Offshore prod'n area	Precautionary area
	Pipeline	Radar line
	Pipeline area	Radar range
	Anchor berth	Radio calling
	Anchorage area	Recommended route centerline
	Cargo transshipment area	Recommended track
	Contiguous zone	Recommended traffic lane part
	Continental shelf area	Traffic separation line
	Custom zone	Traffic separation scheme boundary
	Dumping ground	Traffic separation scheme crossing
	Exclusive economic zone	Traffic separation scheme lane part
	Fishery zone	Traffic separation scheme roundabout
	Fishing ground	Traffic separation zone
	Free port area	Two-way route part
	Harbour area (administrative)	
	Incineration area	
	Log pond	
	National territorial area	
	Sea area	
	Spoil ground	
	Straight territorial sea baseline	
	Submarine transit lane	
	Territorial sea area	
	Restricted area	
	Sea Plane landing area	
	Military practice area	
MARINE FEATURES	Tideways & Currents	Seabed bottom
	Tideway	Sand waves
	Water turbulence	Seabed area
	Tide height	Spring
		Weed/Kelp

Menu Option	Chart Features			
LAND FEATURES	Natural Features	Cultural Features	Building, religious	
	Coastline	Airport area	Building, single	
	Dune	Built-up area	Cemetery	
	Hill	Railway	Fortified Structure	
	Land elevation	Road crossing	Siloway route part	
	Land region	Road part	Tank	
	Land	Runway	Chimney	
	Salt pan	Sloping ground	Dish aerial	
	Slope topline	Square	Flagstaff/flagpole	
	Tree	Cable, overhead	Flarestack	
	Vegetation area	Fence	Mast	
	Natural Features -	Pipeline, overhead	Monument	
	Rivers	Pylon	Radar dome plane landing area	
	Canal	Telepheric	Tower	
	Canal bank	Tunnel entrance	Windmill	
	Rapids		Windmotor	
	River			
	River bank			
	Waterfall			
	Lake			
	Lake shore			
	ICON DISPLAY	Complex (detailed) object/Simple object		

The following chart features are always displayed:

Menu option	Chart features
PORTS	Ports: Berthing facility Causeway Checkpoint Crane Dam Distance mark Dock area Dry dock Dyke area Dyke crown Floating dock Gate Gridiron Harbour facility Hulk Landing place Landing stairs Lock basin Oil barrier Pile Pontoon Ramp Shoreline construction Slipway Weir Small craft facility Services Coastguard station Pilot boarding place Rescue station Signal station, traffic Signal station, warning Port Information Port area Harbour master Coast Guard Police Customs Health emergency Post office Yacht club Boat yard Accessories Electrical/electronic repairs Engine repairs Sailmaker Fishing/diving gear, SCUBA Hotel/Inn Restaurant Bank/Exchange office Pharmacy Port/Marina Slipway Boat hoist Crane Fuel station Water Electricity Showers Launderette Public toilets Post box Public telephone Refuse bin Visitor's berth Chandler Provisions Bottle gas Car Parking Parking for boat and trailers Caravan site Camping site Sewerage pump-out station
CARTOGRAPHIC OBJECTS	Line, generic Area, generic
NATURAL FEATURES	Land area Bridge

The following chart features are always displayed:

Menu option	Chart features
ROCKS	Underwater Rock
WRECKS	Wrecks
DEPTHS 1	Depth area
DEPTHS 2	Dredged area
DEPTHS 3	Intertidal area
PORTS	Mooring/Warping facility
CAUTION AREAS	Fish haven
OFFSHORE INSTALLATIONS	Diffuser Obstruction Production installation Offshore platform
AREAS, LIMITS	No data area
CARTOGRAPHIC OBJECTS	Incomplete survey area
NATURAL FEATURES (Ice)	Ice area Pingo
COMPOSITE OBJECTS	Airport Anchorage Channel edge Deep water route Defined water Harbour Range system Lighthouse Mooring trot Navigation mark, afloat Navigation mark, fixed in point Traffic Separation Scheme System
CARTOGRAPHIC AREAS	Cartographic I125 area

Appendix D: SeaTalk and NMEA Data Received and Transmitted

The following table defines the data received on the NMEA/SeaTalk ports. Data sources are listed in order of priority except where indicated.

Data Received	Source
Position (LAT/LON)	SeaTalk, GGA, RMC, RMA, GLL
Position (Loran C TD's)	GLC, RMA, GTD
Speed and Course Over Ground	SeaTalk, RMC, RMA, VTG
Waypoint Data	SeaTalk, RMB, APB, BWC, BWR, RMB, XTE
Depth	SeaTalk, DBT, DPT
Apparent Wind Angle and Speed	SeaTalk, MWV (relative)
Boat Speed Through Water	SeaTalk, VHW
Total Log and Trip Log	SeaTalk, VLW
Water Temperature	SeaTalk, MTW
Average Boat Speed through the Water	SeaTalk only
Heading	HDG, HDM, HDT, VHW, SeaTalk,
Locked Heading	SeaTalk only (Autopilot / Steering Compass)
Magnetic Variation	SeaTalk, RMC, RMA, HDG
Rudder Angle (not displayed)	SeaTalk only
Time (No priority)	SeaTalk, ZDA, GGA, RMC, GLL, BWC, BWR
Date	SeaTalk, ZDA, RMC
MOB data	SeaTalk only
Autopilot Status (Standby / Auto / Vane / Track)	SeaTalk only
Cursor Range and Bearing (from Chartplotter)	SeaTalk only
Cursor Range and Bearing (from Radar)	SeaTalk, RSD
Global Alarms - Watch alarm, Wind alarm, Autopilot alarms, Depth alarms.	SeaTalk Only
Waypoint arrival	SeaTalk, RMB, APB
Waypoint/Route Transfer	SeaTalk, WPL, RTE

* If Magnetic Heading is not available, the True Heading and Variation (if available) are used to generate the magnetic heading.

The *hsb²* series display unit transmits the following data, if available, on SeaTalk:

Data Output	SeaTalk	NMEA Out
Position (LAT/LON)	✓	GGA, GLL, RMC ¹ , RMA
Position (Loran C TD's)	✓	RMA
Speed Over Ground and Course Over Ground	✓	RMC, VTG ¹ , RMA
Waypoint Data	✓	RMB, APB, BWC, BWR ¹
Depth	✓	DBT, DPT ³
Apparent Wind Angle and Speed	✓	—
Boat Speed Through Water	✓	VHW ³
Total Log and Trip Log	✓	VLW ³
Water Temperature	✓	MTW ³
Heading	✓	VHW ^{3,4}
Magnetic Variation	✓	RMA, RMC
Time	✓	ZDA
Date	✓	ZDA
MOB data	✓	—
Cursor Range & Bearing	✓	RSD ²
EBL/VRM Data	—	RSD ²
Heading mode	—	RSD ²
Radar display range	✓	RSD ²
Radar Tracked targets	—	TTM
Waypoint/Route Transfer	—	WPL, RTE
Global Alarm	SeaTalk	—
Waypoint Arrival Alarm		APB, RMB

¹When available, NMEA OUT data is transmitted from RL70RC and RC520, or from RL70 if connected to a Chart display via *hsb²*.

²When available, NMEA OUT data is transmitted from RL70 and RL70RC, or from a RC520 if connected to a Radar display via *hsb²*.

³ Fishfinder data.

⁴ Bridged from NMEA if selected in the System Set Up menu.

Appendix E: Connecting a Raymarine Heading Sensor

The performance of MARPA and radar/chart overlay on the *hsb²* displays is dependent on the quality of your heading sensor.

Raymarine recommend that, for optimum MARPA and radar/chart overlay operation, you use Raymarine Rate Gyro Compass or a G-series course computer, connected via NMEA, as your source of heading data. The G-series course computer uses rate gyro compensation.

This Appendix provides connection details for a Raymarine 150G or 400G course computer. For information on the Rate Gyro Compass refer to the handbook supplied with the compass. *Figure 8-15 on page 26* shows a typical Pathfinder system with a Rate Gyro Compass system.

If you have a different heading sensor, or require further assistance, please contact your authorized Raymarine dealer or Raymarine Technical Support.

G-Series Course Computer

Note: *A 150 or 400 course computer coupled to the optional GyroPlus unit will provide heading data of equal quality to the 150G or 400G course computer. The method of connecting to your *hsb²* display is the same.*

If you have a Raymarine 150G or 400G course computer we recommend that you configure your system as follows and illustrated below:

- Connect the course computer NMEA1 output to the NMEA input on each of your displays that will be used for MARPA and radar/chart overlay.
- For each display, in the System Set Up Menu set Bridge NMEA Heading OFF (see *Bridge NMEA Heading on page 7-8*).

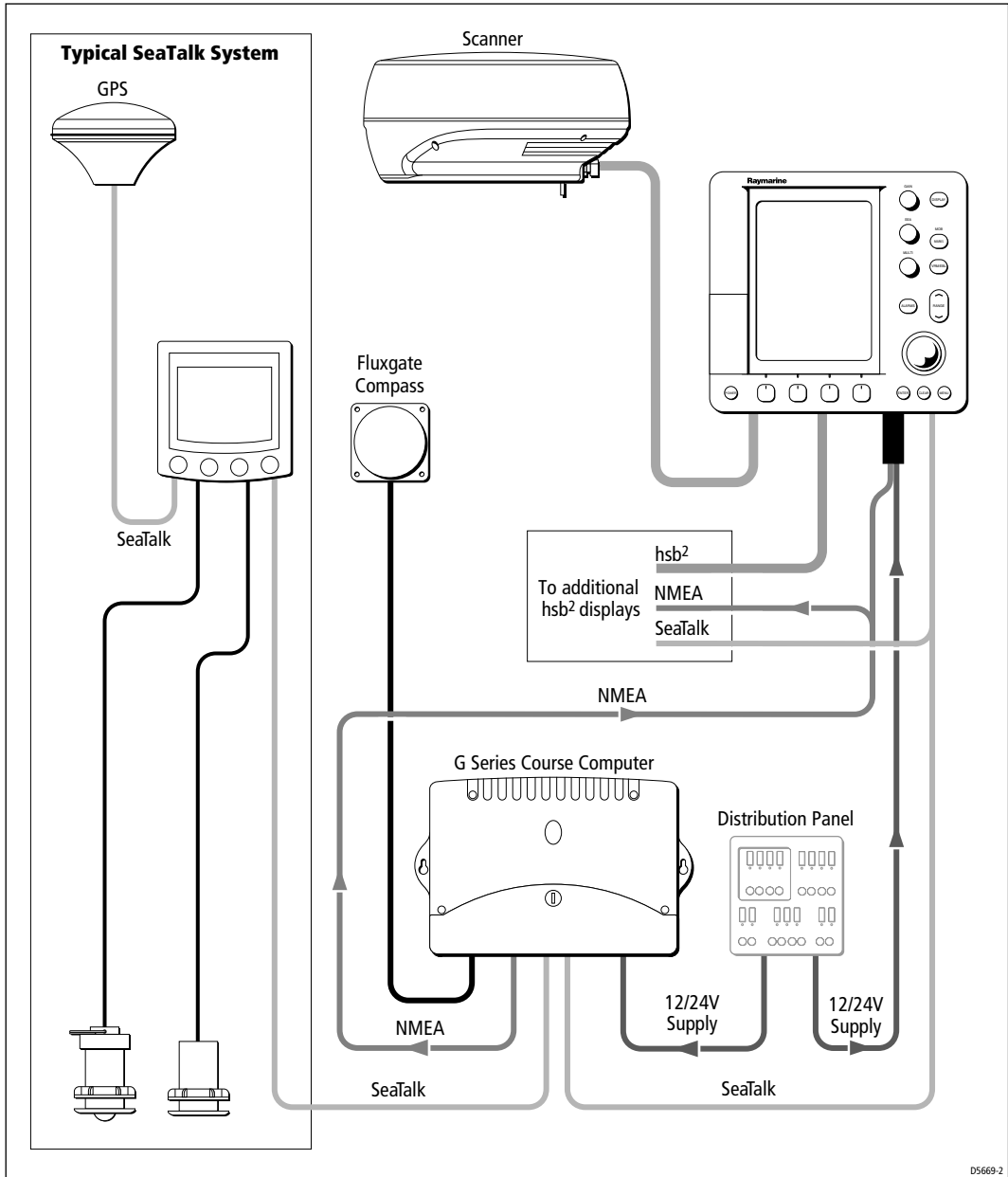

Figure E-1: *hsb²* System with a G-Series Course Computer

D5669-2

Appendix F: Abbreviations

A	Amp
ANSI	American National Standards Institute
AWG	American Wire Gauge
BDI	Bearing and Distance Indicator
Brg	Bearing
CCFL	Cold Cathode Fluorescent Lamp
CD	Course Deviation Indicator
CFR	Code of Federal Regulations
CMG	Course Made Good
COG	Course Over Ground
CRT	Cathode Ray Tube
CTR	Center
dB	deciBels
DC	Direct Current
DMG	Distance Made Good
DR	Dead Reckoning
EBL	Electronic Bearing Line
EMC	Electro Magnetic Compatibility
ETA	Estimated Time of Arrival
FCC	Federal Communication Commission
FLT	Float - floating EBL/VRM
ft	feet
FTC	Fast Time Constant
GPS	Global Positioning System
dGPS	differential Global Positioning System
GRD	Guard Zone
GHz	Giga Hertz
HDG	Heading
<i>hsb²</i>	High Speed Bus
Hz	Hertz
MHz	Mega Hertz
IEEE	Institute of Electrical & Electronic Engineers
in, "	inch
Kg	kilogram
kW	kilo Watt

lat	latitude
lbs	pounds
LCD	Liquid Crystal Display
lon	longitude
M	Magnetic
m	meters
MARPA	Mini Automatic Radar Plotting Aid
MBS	Main Bang Suppression
mm	millimeter
MOB	Man OverBoard
MRK	Mark
nm	nautical mile
NMEA	National Marine Electronics Association
POS	Position (of vessel)
RF	Radio Frequency
Rng	Range
rpm	Revolutions Per Minute
SSB	Single Side Band
SHM	Ships Heading Marker
SOG	Speed Over Ground
STC	Sensitivity Time Control
T	True
TFT	Thin Film Transistor
TTG	Time To Go
V	Volts
VHF	Very High Frequency
VMG	Velocity Made Good
VRM	Variable Range Marker
WPT	Waypoint
XTE	Cross Track Error
yds	yards
ZMB	Zoom Box

Index

A

- Accessories 8.4
 - Acquire
 - a Target 3.26
 - Adding
 - a Waypoint to a Route 5.19, 5.28
 - Adjusting Gain, Sea Clutter and Rain Clutter 3.7
 - Advanced Set Up 7.2, 7.15
 - Display Timing 7.15
 - STC Preset 7.16
 - Tune Preset 7.16
 - Alarm Clock Alarm 6.4
 - Alarms 3.1, 3.22
 - Alarm Clock 6.4
 - Anchor 6.4
 - Arrival 5.32, 6.4
 - Controlling Guard Zones 3.19, 3.22
 - Countdown Timer 6.4
 - External 6.4
 - MOB 4.5, 6.6
 - Off Track 6.4
 - Setting 6.1, 6.5
 - ALARMS Key 1.18, 3.19, 3.20, 6.4, 6.5
 - Alignment
 - Bearing 7.11, 7.13, 8.18
 - Anchor Alarm 6.4
 - Antenna Size 7.11, 7.13
 - Apelco 182 and 182XT GPS B.2
 - Arrival Alarm 5.32, 6.4
 - Autohelm GPS, Z260 and Z273 B.3
- ## B
- BDI
 - Window Options 1.6, 1.8, 2.10
 - Bearing
 - Alignment 7.11, 7.13, 8.18
 - Bearing Mode 7.4, 7.6
 - Blind Sectors 3.6
 - Bridge NMEA Heading 7.5, 7.8, 8.30
 - Brightness Control 2.6
- ## C
- Cable Runs 8.8
 - Installation Considerations 8.2
 - Cables
 - HSB2 8.9
 - Inter-unit 8.9
 - Power 8.8
 - Cancel
 - a Target 3.26
 - MOB 4.6, 6.7
 - CDI
 - Window Options 1.6, 1.8, 2.10

- Center Control (Radar) 2.17
- Center the Chart 1.13, 2.19
- Changing the Heading Mode 4.1
- Changing the Radar Range 3.2
- Changing the Targets Display 3.11
- Chart
 - Center 1.13, 2.19
 - Data 4.1, 5.2
 - Nearest 5.7
 - Object Information 5.4, 7.17, 7.19
 - Port 5.4, 5.5
 - Source 5.4
 - Tide 5.4, 5.6
 - Definition 1.3
 - Mode 1.6, 1.8
 - Full Screen 2.7
 - Orientation 7.17, 7.18
 - Course Up 7.18
 - Head Up 7.18
 - North Up 7.18
 - Scale 2.19, 2.21, 5.2, 6.6
 - Simulator 2.1, 2.5, 7.10
- Chart Card 1.4, 1.13
 - Object Information 5.4, 7.17, 7.19
- Chart Grid
 - On and Off 2.13
- Chart Master 1.3
- Chart Repeater 1.3
- Chartplotter
 - Control Functions 2.19
 - Display Options 1.14
 - Features 1.13, A.3
 - Functions 1.15
 - Set Up 7.2, 7.17
 - Custom Options 1.14, 2.15
 - Radar/Chart Synch 1.13, 2.20, 7.17
 - Window Options 1.8
- Cleaning Instructions 9.1
- CLEAR Key 1.18
- Clearing
 - a Track 5.38, 5.40
 - Marks 7.11, 7.12
 - the Current Route 5.18, 5.23
 - Wakes 3.12
- COG (Course Over Ground) 6.1
 - Data Box 7.4
 - Vector 7.17, 7.19
- Combined Display
 - Definition 1.3
 - Operating Modes 1.6, 1.8
- Combined Radar/Chartplotter
 - Identifying Objects 3.1
 - Identifying Objects with Cursor Echo 4.6, 6.7
 - Radar/Chart Overlay 2.23
 - Switching Control 2.9

- Connections 8.12
 - Display Unit 8.13
 - HSB2 8.13, 8.22
 - NMEA Input 8.13, 8.24, 8.28
 - NMEA Output 8.13, 8.30, 8.31
 - Power 8.12
 - Power & NMEA In 8.13, 8.15, 8.28
 - Scanner 8.13, 8.14
 - SeaTalk 8.13, 8.24, 8.27
- Context-sensitive Cursor 1.17, 2.19
- Control Functions
 - Chartplotter 2.19
 - Radar 2.16
- Controlling Guard Zone Alarms 3.19, 3.22
- Conventions Used 2.1
- Countdown Timer Alarm 6.4
- Course Up 4.2, 7.18
- Creating a Route 5.18
 - by Placing Waypoints 5.19
 - from a Track 5.39, 5.42
 - Using the Waypoint List 5.20
- Cross Track Error - See XTE
- Current Route 5.18
 - Altering 5.30
 - Clearing 5.18, 5.23
- Cursor 1.16
 - Context-sensitive 1.17, 2.19
 - Data Box 2.13
 - Goto 5.30, 5.34
 - Moving 1.17
 - Readout 7.4, 7.6
 - Reference 7.4, 7.6
- Cursor Echo 3.1, 4.1, 6.1, 6.7, 7.5, 7.9
 - Chart 4.6, 6.7, 7.9
 - Local 4.6, 6.7, 7.9
 - Radar 4.6, 6.7, 7.9
 - SeaTalk 4.6, 6.7, 7.9
- Custom Options
 - Chartplotter 1.14, 2.15
- Customizing
 - the Chart Display 7.17
 - the Screen Presentation Options 2.13
- D**
- Data Box 2.14, 7.4, 7.6
 - COG 7.4
 - Cursor 2.13
 - Date 7.4
 - Depth 7.4
 - Group of Six 2.14
 - On/Off 2.14
 - Heading 7.4
 - List of 7.4
 - Log/Trip 7.4
 - MARPA Target 3.27
 - MOB 4.5, 6.6
 - Moving 2.14, 3.18
 - On/Off 3.18
 - Pilot 7.4
 - Position 7.4
 - Ruler 6.2, 6.3
 - SOG 7.4
 - Speed 7.4
 - Temperature 7.4
 - Tide Set/Drift 7.4
 - Time 7.4
 - VMG 7.4
 - VRM/EBL 3.18
 - Waypoint 7.4
 - Wind 7.4
 - XTE 7.4
- Data Conversion 8.30
- Data Display 5.25
 - Chart Object 5.4, 7.17, 7.19
 - Nearest 5.7
 - Port 5.4, 5.5
 - Source 5.4
 - Tide 5.4, 5.6
 - Route 5.19, 5.24
- Data from other Equipment 4.1, 6.1, 6.6, 8.30
 - Chart 4.1
 - COG 6.1
 - Heading 1.9, 2.23, 3.23, 4.1, 4.5, 6.1, 6.6, 7.8
 - HSB2 4.1, 6.1
 - Navigation Data 4.1
 - NMEA 4.1, 4.4, 6.1, 8.28
 - Position 1.9, 2.23, 4.1, 4.5, 6.1, 6.6
 - Radar 6.1
 - SeaTalk 4.1, 4.4, 4.6, 6.1, 6.7, 8.26
 - Speed 4.5, 6.6
 - Waypoint 4.1
- Data Log Mode 1.6, 1.8, 6.1, 6.10
 - Full Screen 2.7
- Database List 1.16, 1.20
 - MARPA 3.26, 3.27
 - Route 5.15, 5.19, 5.22, 5.25
 - Retrieving 5.23
 - Track 5.41
 - Waypoint 5.8, 5.9, 5.13, 5.14, 5.20, 5.33
- Date Data Box 7.4
- Date Format 7.5, 7.9
- Datum Selection 7.17, 7.19
- Day/Night 7.4, 7.7
- Dedicated Controls
 - MULTI 3.5
- Dedicated Keys 1.4, 1.16, 1.18
 - ALARMS 1.18, 3.19, 3.20, 6.4, 6.5
 - CLEAR 1.18
 - DISPLAY 1.8, 1.18, 2.7, 2.8, 2.24, 6.10
 - ENTER 1.18
 - GAIN 2.24, 3.5, 3.7
 - MARKS 1.18, 4.4, 4.5, 5.9, 5.12, 5.36, 5.37, 6.6
 - MENU 1.18, 2.5, 5.39, 6.8, 7.1, 7.2

- MULTI 2.6, 3.7, 3.22
- POWER 1.18, 2.2, 2.3, 2.4
- RANGE 1.18, 2.21, 2.22, 3.2, 5.2
- VRM/EBL 1.18, 3.13, 3.14, 6.1, 6.3
- Deleting
 - a Guard Zone 3.19, 3.21
 - a Mark 4.5
 - a VRM/EBL 3.16
- Deleting - See also Erasing
- Depth Data Box 7.4
- Determining Radar Range 3.3
- D-GPS Set Up
 - Beacon Frequency 6.9
 - Beacon ID 6.9
 - Bit Rate 6.9
 - Differential Age 6.9
 - Signal Strength & Signal to Noise Ratio 6.9
- Display
 - Brightness 2.6
 - Cleaning 9.1
 - Features 1.5
 - Lighting 2.6
 - Operating Modes 1.6
 - Selecting 2.7
 - Set Up Options 1.6
- DISPLAY Key 1.8, 1.18, 2.7, 2.8, 2.24, 6.10
- Display Options
 - Chartplotter 1.14
 - Radar 1.10
- Display Timing Set Up 7.15
- Display Unit 1.iii, 1.4
 - Connections 8.13
 - Console Mounting 8.10
 - Grounding 8.12
 - Location 8.5
 - Mounting 8.10
 - Specification A.1
 - Switching Off 2.4
- Displaying
 - a Waypoint 2.14
 - Bearing Data (EBLs) 7.11
 - Chart Data 5.3
 - Waypoint Data 5.8, 5.12, 5.25
- Displaying the Radar and Synchronising Radar & Chart 2.32
- E**
- EBL (Electronic Bearing Lines) 3.1, 3.13
 - Display 7.11
- Echoes 3.4
 - False 3.5
 - Indirect 3.6, 3.13
 - Multiple 3.6
- Editing
 - a Route 5.19, 5.27
 - a Waypoint 5.8
 - Using the ST60/80 Navigator Keypad 5.17
 - Waypoint Details 5.13
- Electromagnetic Energy 1.iii
- EMC
 - Conformance 1.vi, 8.20
 - Servicing and Safety Guidelines 9.1
- ENTER Key 1.18
- Erasing
 - a Route 5.19, 5.26
 - a Waypoint 5.8, 5.14
- Expansion (Radar Targets) 3.5, 3.11, 3.12
- External Alarms 6.4
- F**
- Factory Reset 9.3
- False Echoes 3.4, 3.5
- Features
 - Chartplotter 1.13, A.3
 - Display 1.5
 - Radar 1.10, A.2
- Find Ship 2.19, 2.20
- Fishfinder
 - Definition 1.3
 - Mode 1.8
 - Window Options 1.8
- Fishfinder Master 1.3
- Fishfinder Repeater 1.3
- Floating VRM/EBLs 3.14, 3.16
- Follow
 - a Route 5.30
 - Route Options 5.30, 5.32
 - Stop 5.30, 5.34
- FTC Control 3.5, 3.7, 3.10
- Functions
 - Chartplotter 1.15
 - Radar 1.12
- G**
- Gain
 - Control 3.5
 - Recommendations 3.8
- GAIN Key 1.18, 2.24, 3.5, 3.7
- Goto
 - a Target 5.30, 5.33
 - a Waypoint 5.30, 5.33
 - Cursor 5.30, 5.34
 - Stop 5.30, 5.34
- GPS
 - Positional Accuracy 6.8
 - Restart GPS 6.9
 - Set Up 6.1, 6.8
- GPS SOG/COG Filter 7.5, 7.10
- G-Series Course Computer E.1
- Guard Zones 3.1, 3.19
 - Controlling Alarms 3.19, 3.22
 - Deleting 3.19, 3.21
 - Moving 3.19, 3.21
 - Placing 3.19, 3.20
 - Reshaping 3.19, 3.21

H

- Half Screen Windows 1.6, 2.7
 - Selecting 2.8
- Head Up 4.2, 7.18
- Heading 7.5, 8.30
- Heading Data 1.9, 2.23, 3.23, 4.1, 4.5, 6.1, 6.6, 7.8, E.1
- Heading Data Box 7.4
- Heading Mode 4.2, 7.18
 - Changing 4.1
 - Course Up 4.2
 - Effect on VRM/EBLs 4.3
 - Head Up 4.2
 - North Up 4.2
 - Selecting 4.3
- Heading Vector 7.17, 7.19
- Help 7.4, 7.7
- Help from Raytheon
 - Europe 9.6
 - US 9.5
- High Voltage 1.iii
- HSB2
 - Cable 8.9
 - Connection 1.5, 8.13, 8.22
 - Data 4.1, 6.1

I

- Identifying False Echoes 3.5
- Identifying Objects 3.1
 - with Cursor Echo 4.6, 6.7
- Indirect Echoes 3.6
- Installation
 - Cable Runs 8.2, 8.8
 - EMC Conformance 8.20
 - EMC Guidelines 8.2
 - Integrated System 8.21
 - Location 8.2, 8.5
 - Multiple Display Systems 8.21
- Integrated System 1.9, 5.18
 - Definition 1.3
 - Diagram 8.25, 8.26
 - Identifying Objects 3.1
 - Installation 8.21
 - Installation Checks 8.31
 - Switching Control Between Radar and Chart 2.9
- Interference Rejection 3.5, 3.11, 3.12
- Interpreting and Adjusting the Radar Picture 3.1, 3.4
- Inter-Unit Cable 8.9
- J**
- Junction Box
 - for External Instruments 8.29
- K**
- Key Beep 7.4, 7.7
- Keys
 - Dedicated 1.4, 1.16, 1.18

Lighting 2.6

Soft 1.4, 1.16, 1.18, 7.4, 7.7

L

- Language 7.5, 7.10
- LCD Display
 - Color 1.1
- Lighting Control
 - Display 2.6
 - Key 2.6
- Local Cursor Echo 4.6, 6.7, 7.9
- Location
 - Display Unit 8.5
- Log/Trip Data Box 7.4
- Loran TDs 5.11
- M**
- Magnetron 2.2
- Maintenance 9.1
- Make and Follow a Route Scenario 2.28
- Managing Tracks 5.39
- Marks 4.1, 4.4, 5.8
 - Clearing 7.11
 - Deleting 4.5
 - Moving 4.5
 - Options 7.11, 7.12
 - Placing 4.4
 - Symbol 7.11, 7.12
- MARKS Key 1.18, 4.4, 4.5, 5.9, 5.12, 5.36, 5.37, 6.6
- MARPA 1.12, 3.1, 3.23
 - Database List 3.26, 3.27
 - Heading Data 1.9
 - Set Up 7.2, 7.14
 - Target Data Box 3.27
- Master Display 1.5, 5.2, 8.22
 - Definition 1.3
- Measuring Distances Using the VRM/EBL Key 6.1, 6.2
- Measuring Range and Bearing 3.1, 3.14
 - Floats 3.14, 3.16
- MENU Key 1.18, 2.5, 5.39, 6.8, 7.1, 7.2
- Menu Timeout 7.4, 7.7
- MOB 4.1, 6.1
 - Alarm 4.5, 6.6
 - Cancel 4.6, 6.7
 - Data Box 4.5, 6.6
 - Data Selection 7.4, 7.7
 - Symbol 4.5, 6.6
 - Waypoint 4.5, 6.6
- Modes 1.8
 - Chart 1.6, 1.8, 2.7
 - Data Log 1.6, 1.8, 2.7, 6.1, 6.10
 - Fishfinder 1.8
 - Full Screen 2.7
 - Radar 1.6, 1.8, 2.7
 - Radar/Chart Overlay 1.6, 1.8, 2.7
- Mounting the Display Unit 8.10
 - Console Mounting 8.10

-
- Moving
 - a Data Box 2.14, 3.18
 - a Floating EBL 3.17
 - a Guard Zone 3.19, 3.21
 - a Mark 4.5
 - a VRM/EBL 3.15
 - a Waypoint 5.9, 5.14, 5.19, 5.27
 - the Cursor 1.17
 - MULTI Key 1.18, 2.6, 3.5, 3.7, 3.22
 - Multiple Display System
 - Connections 8.23
 - Installation 8.21
 - Operating Modes 1.8
 - Multiple Echoes 3.4, 3.6
 - N**
 - Naming
 - a Route 5.19, 5.22, 5.26
 - a Track 5.41
 - a Waypoint 5.8, 5.13, 5.17
 - Using the ST60/80 Navigator Keypad 5.17
 - Nav Data
 - from other Equipment 4.1
 - Window Options 1.8, 2.10
 - Navigation Aid 1.iii
 - Navigational Echoes 3.4
 - Navigator Keypad 5.9, 5.15
 - NMEA 1.9
 - Data 4.1, 4.4, 6.1, 8.28
 - Heading 7.5, 7.8, 8.30
 - Input Connection 8.13, 8.24, 8.28
 - Output Connection 8.13, 8.30, 8.31
 - NMEA Out Set Up 7.5, 7.9
 - North Up 4.2, 7.18
 - O**
 - Object Information - Chart 7.17, 7.19
 - Displaying 5.4
 - Off Track Alarm 6.4
 - Offsetting the Center 1.10, 1.13
 - Range Rings 2.18
 - Open Array Scanner
 - Antenna Size 7.11, 7.13
 - Operating Controls
 - Cursor 1.16
 - Database List 1.16, 1.20
 - Dedicated Keys 1.4, 1.16, 1.18
 - Pop-up Menus 1.16, 1.19
 - Soft Keys 1.4, 1.16, 1.18, 7.4, 7.7
 - Trackpad 1.4, 1.16, 2.19
 - Operating Modes 1.6
 - Chart 2.7
 - Combined Display 1.6
 - Data Log 2.7, 6.1, 6.10
 - Operating Modes
 - Multiple Display System 1.8
 - Plotter 2.22, 7.17, 7.18
 - Radar 2.7
 - Radar/Chart Overlay 2.7, 2.23
 - Selecting 2.7
 - Single Display 1.6
 - Switching Control 2.9
 - Orientation - Chart 7.17, 7.18
 - Overlaying Radar onto Chart 1.13, 2.23
 - P**
 - Picture Reset 9.3
 - Pilot Data Box 7.4
 - Place and Goto a Waypoint Scenario 2.26
 - Placing
 - a Guard Zone 3.19, 3.20
 - a Mark 4.4
 - a VRM/EBL 3.14
 - a Waypoint 5.8, 5.9, 5.19
 - Plotter Mode 2.22, 7.17, 7.18
 - Pop-up Menus 1.16, 1.19
 - Port Data 5.4, 5.5
 - Position
 - a Waypoint 5.8, 5.13
 - Position Data 1.9, 2.23, 4.1, 4.5, 6.1, 6.6
 - Position Data Box 7.4
 - Position Offset 7.17, 7.20
 - Positional Accuracy 6.8
 - Power
 - Cable 8.8
 - Connection 8.12
 - for External Equipment 8.12, 8.21
 - Power & NMEA Input
 - Connection 8.13, 8.15, 8.28
 - POWER Key 1.18, 2.2, 2.3, 2.4
 - Power-on Reset 9.3
 - Power-on Sequence 2.2, 2.4
 - Chart Mode 2.4
 - Radar Mode 2.2
 - Predicted Position 7.14
 - R**
 - Radar
 - Control Functions 2.16
 - Features 1.10, A.2
 - Functions 1.12
 - Mode
 - Full Screen 2.7
 - Range
 - Changing 3.2
 - Custom Scale 7.11, 7.12
 - Set Up 7.2
 - Radar/Chart Synch 1.13
 - Simulator 2.1, 2.5
 - System Alignment 8.16
 - System Test 8.16
 - Timing Adjustment 8.19
 - Typical System Diagram 8.1
 - Window Options 1.8, 2.10
 - Radar Display
 - Center Control 2.18

- Definition 1.3
- Options 1.10
- Range Rings 2.18
- Radar Master 1.3
- Radar Mode 1.6, 1.8
- Radar Repeater 1.3
- Radar System 1.5
- Radar/Chart Overlay 1.13, 2.23
 - Heading Data 1.9
 - Mode 1.6, 1.8, 2.7
- Radar/Chart Synchronization 1.13, 2.20, 7.17
- Rain Control 3.5, 3.9
 - Distant Rain 3.10
- Range
 - Control 3.1
 - Determining 3.3
 - Scale
 - Custom 3.2, 7.11, 7.12
- RANGE Key 1.18, 2.21, 2.22, 3.2, 5.2
- Range Rings 2.18, 3.2, 3.3
 - On and Off 2.13
- Raystar 112 and 105 GPS B.2
- Raystar 112LP GPS B.4
- Raystar 114 GPS B.5
- Raystar 120 WAAS GPS Receiver B.6
- RC530 PLUS Chartplotter 1.1
- RC631 PLUS Chartplotter 1.1
- Remote Cursor Echo
 - Chart 4.6, 6.7, 7.9
 - Radar 4.6, 6.7, 7.9
- Removing
 - a Waypoint from a Route 5.19, 5.28
- Repeater Display 1.5, 5.2, 5.18, 8.22
 - Definition 1.3
- Reshaping
 - a Guard Zone 3.19
- Restart
 - GPS 6.9
 - XTE 5.30, 5.33
- Retrieving a Route 5.19, 5.23
- Returning to the Full-Screen Display 2.9
- Reverse a Route 5.27, 5.29
- Review Your Passage Plan Scenario 2.30
- RL70C PLUS Pathfinder Radar 1.1
- RL70CRC PLUS Pathfinder Radar 1.1
- RL80C PLUS Pathfinder Radar 1.1
- RL80CRC PLUS Pathfinder Radar & Chartplotter 1.1
- Route
 - Clearing 5.18
 - Creating 5.18
 - Creating from a Track 5.39, 5.42
 - Current 5.18
 - Data Display 5.19, 5.24
 - Database List 5.15, 5.19, 5.22, 5.23, 5.25
 - Editing 5.19, 5.27
 - Using the ST60/80 Navigator Keypad 5.17
 - Erasing 5.19, 5.26
 - Follow 5.30
 - Loading from a User Cartridge 5.35
 - Naming 5.19, 5.22, 5.26
 - NMEA Transfer 5.35
 - Retrieving 5.19, 5.23
 - Reversing 5.27, 5.29
 - Saving 5.18
 - Saving to a User Cartridge 5.35
 - Transferring 5.18, 5.35
- Route Leg 5.18
 - Data Display 5.24
- Routine Checks 9.1
- Ruler Data Box 6.2, 6.3
- S**
- Safe Zone 7.14
- Safety 1.iii, 5.1
 - Electromagnetic Energy 1.iii
 - EMC Guidelines 8.2, 9.1
 - Navigation Aid 1.iii
- Saving
 - a Route 5.18
 - a Track 5.41
- Scale
 - Chart 2.19, 5.2, 6.6
 - Radar Range 3.2
 - Custom 7.11, 7.12
- Scanner 1.iii, 1.4
 - Connection 8.13, 8.14
 - Modes
 - Scanner Off 2.2, 2.3
 - Standby 1.4, 2.2, 2.3
 - Timed Transmit 1.4, 7.11, 7.12
 - Transmit 1.4, 2.2
 - Switching Off 2.4
 - Transmission Check 8.17
- Scanner Off Mode 2.2, 2.3
- Scenarios
 - Displaying the Radar and Synchronising Radar & Chart 2.32
 - Make & Follow a Route 2.28
 - Place & Goto a Waypoint 2.26
 - Review Your Passage Plan 2.30
- Sea Clutter
 - Control 3.5
 - Recommendations 3.9
- SeaTalk 1.9
 - Connection 8.13, 8.24, 8.27
 - Cursor Echo 7.9
 - Data 4.1, 4.4, 4.5, 4.6, 6.1, 6.7, 8.26
- Selecting
 - a Half Screen Window 2.8
 - a Waypoint 5.8, 5.12
 - the Heading Mode 4.3
 - the Operating Mode 2.7
- Send on HSB 7.11, 7.13

-
- Servicing
 - EMC Guidelines 9.1
 - Set Up Options 1.6, 2.15
 - Set Up Parameters
 - GPS Set Up 6.9
 - Setting Up
 - a GPS 6.9
 - Setting Alarms and Timers 6.1, 6.5
 - Setting Up
 - a GPS 6.1, 6.8
 - Advanced Radar Options 7.2, 7.15
 - Chart Parameters 7.2, 7.17
 - GPS Set Up
 - Restart GPS 6.9
 - Initial Set Up 8.16
 - MARPA 7.2, 7.14
 - Radar Parameters 7.2
 - System Parameters 7.2
 - Tracks 5.38, 5.39
 - Shadows 3.6
 - SHM (Ship's Heading Marker) 1.10, 3.19
 - Head Up Mode 2.18
 - Side Lobes 3.5
 - Simulator 7.5, 7.10
 - Chart 2.1, 2.5
 - Radar 2.1, 2.5
 - SmartRoute 5.42
 - Soft Key Labels 7.7
 - Soft Keys 1.4, 1.16, 1.18, 7.4, 7.7
 - SOG (Speed Over Ground) Data Box 7.4
 - Speed 4.5, 6.6
 - Data Box 7.4
 - ST60/80 Navigator Keypad 5.9, 5.15, 5.17
 - Standby Mode 1.4, 2.2, 2.3
 - Status Bar 1.10, 1.13
 - STC Preset 7.16
 - Stop
 - Follow 5.30, 5.34
 - Goto 5.30, 5.34
 - Track - See Clear Track
 - Switching
 - Chart Grid On and Off 2.13
 - Chartplotter On 2.4
 - Cursor Data Box On and Off 2.13
 - Databoxes On/Off 2.14, 3.18
 - Display On and Off 2.4, 8.16
 - Range Rings On and Off 2.13
 - Scanner Off 2.4
 - Symbol
 - Marks 7.11, 7.12
 - MOB 4.5, 6.6
 - Waypoint 5.8, 5.13, 7.17, 7.19
 - Synchronize Chart and Radar 1.13, 2.20, 7.17
 - System
 - Connections 8.12
 - Grounding 8.12
 - Set Up 7.2
 - T**
 - Target (Chart) 5.30
 - Arrival 5.30
 - Goto 5.30
 - Waypoint 5.30
 - Targets (MARPA) 1.12, 3.1
 - Acquire 3.26
 - Cancel 3.26
 - Data 3.27
 - History 7.14
 - Vector 7.14
 - Targets (Radar) 1.4, 2.3
 - Control 3.5
 - Expansion 3.5, 3.11, 3.12
 - Interference Rejection 3.5, 3.11, 3.12
 - Wakes 3.5, 3.11
 - Tracking 3.1
 - Wakes 3.12
 - Temperature Data Box 7.4
 - Terminology 1.3
 - Tide Data 5.4, 5.6
 - Tide Set/Drift Data Box 7.4
 - Tide Vector 7.17, 7.19
 - Time Data Box 7.4
 - Time Format 7.5
 - Time Offset 7.5
 - Timed Transmit Mode 1.4, 7.11, 7.12
 - Timers
 - Alarm Clock 6.4
 - Countdown 6.4
 - Setting 6.1
 - Trackpad 1.4, 2.19
 - Tracks
 - Clearing 5.38, 5.40
 - Converting to Route 5.42
 - Database List 5.41
 - Managing 5.39, 5.41
 - Naming 5.41
 - Using the ST60/80 Navigator Keypad 5.17
 - Saving 5.41
 - Setting Up 5.38, 5.39
 - Transferring
 - a Route 5.18, 5.35
 - a Waypoint 5.8, 5.18, 5.35
 - Transmission Check 8.17
 - Transmit Mode 1.4, 2.2, 2.3
 - Tune Preset 7.16
 - Tuning the Receiver 3.5, 3.9
 - U**
 - Units 7.4, 7.7
 - User Cartridge 5.35

V

- Variation Source 7.5, 7.8
- Vectors 7.17, 7.19
 - MARPA Target 7.14
- VMG Data Box 7.4
- VRM (Variable Range Markers) 3.1, 3.13
- VRM/EBL 3.14, 3.15, 3.16
 - Effect of Heading Mode 4.3
- VRM/EBL Key 1.18, 3.13, 3.14, 6.1, 6.3

W

- WAAS B.6
- Wakes 3.5, 3.11
 - Clearing 3.12
- Warranty 1.vi
- Waypoint 2.14, 4.1, 7.17, 7.19
 - Adding to a Route 5.19, 5.28
 - Data Box 7.4
 - Data Display 5.8, 5.12, 5.25
 - Database List 5.8, 5.9, 5.13, 5.14, 5.20, 5.33
 - Displaying 2.14
 - Editing 5.8
 - Editing Details 5.13
 - Erasing 5.8, 5.14
 - Goto 5.30
 - Loading from a User Cartridge 5.35
 - MOB 4.5, 6.6
 - Moving 5.9, 5.14, 5.19, 5.27
 - Naming 5.8, 5.13
 - Numbers 7.14, 7.17, 7.19
 - Placing 5.8, 5.9, 5.19
 - Position 5.8, 5.13
 - Removing from a Route 5.19, 5.28
 - Saving to a User Cartridge 5.35
 - Selecting 5.8, 5.12
 - Symbol 5.8, 5.13, 7.17, 7.19
 - Target 5.30
 - Transferring 5.8, 5.18, 5.35
 - Transferring on NMEA 5.35
 - Transferring on SeaTalk 5.35
- Waypoint List
 - Creating a Route 5.20
- Wind Data Box 7.4
- Window Options
 - BDI 1.6, 1.8, 2.10
 - CDI 1.6, 1.8, 2.10
 - Chartplotter 1.8, 2.10
 - Fishfinder 1.8
 - Full Screen 1.6
 - Half Screen 1.6, 2.7
 - Nav Data 1.8, 2.10
 - Radar 1.8, 2.10
- World Map 1.13, 5.2

X

- XTE (Cross Track Error)
 - Data Box 7.4
 - Restart 5.30, 5.33

Z

- Zoom 1.10, 1.13, 2.16

Limited Warranty Certificate

Raymarine warrants each new Light Marine/Dealer Distributor Product to be of good materials and workmanship, and will repair or exchange any parts proven to be defective in material and workmanship under normal use for a period of 2 years/24 months from date of sale to end user, except as provided below.

Defects will be corrected by Raymarine or an authorized Raymarine dealer. Raymarine will, except as provided below, accept labor cost for a period of 2 years/24 months from the date of sale to end user. During this period, except for certain products, travel costs (auto mileage and tolls) up to 100 round trip highway miles (160 kilometres) and travel time of 2 hours, will be assumed by Raymarine only on products where proof of installation or commission by authorized service agents, can be shown.

Warranty Limitations

Raymarine Warranty policy does not apply to equipment which has been subjected to accident, abuse or misuse, shipping damage, alterations, corrosion, incorrect and/or non-authorized service, or equipment on which the serial number has been altered, mutilated or removed.

Except where Raymarine or its authorized dealer has performed the installation, it assumes no responsibility for damage incurred during installation.

This Warranty does not cover routine system checkouts or alignment/calibration, unless required by replacement of part(s) in the area being aligned.

A suitable proof of purchase, showing date, place, and serial number must be made available to Raymarine or authorized service agent at the time of request for Warranty service.

Consumable items, (such as: Chart paper, lamps, fuses, batteries, styli, stylus/drive belts, radar mixer crystals/diodes, snap-in impeller carriers, impellers, impeller bearings, and impeller shaft) are specifically excluded from this Warranty.

Magnetrons, Cathode Ray Tubes (CRT), TFT Liquid Crystal Displays (LCD) and cold cathode fluorescent lamps (CCFL), hailer horns and transducers are warranted for 1 year/12 months from date of sale. These items must be returned to a Raymarine facility.

All costs associated with transducer replacement, other than the cost of the transducer itself, are specifically excluded from this Warranty.

Overtime premium labor portion of services outside of normal working hours is not covered by this Warranty.

Travel cost allowance on certain products with a suggested retail price below \$2500.00 is not authorized.

When/or if repairs are necessary, these products must be forwarded to a Raymarine facility or an authorized dealer at owner's expense will be returned via surface carrier at no cost to the owner.

Travel costs other than auto mileage, tolls and two (2) hours travel time, are specifically excluded on all products. Travel costs which are excluded from the coverage of this Warranty include but are not limited to: taxi, launch fees, aircraft rental, subsistence, customs, shipping and communication charges etc. Travel costs, mileage and time, in excess to that allowed must have prior approval in writing.

TO THE EXTENT CONSISTENT WITH STATE AND FEDERAL LAW:

(1) THIS WARRANTY IS STRICTLY LIMITED TO THE TERMS INDICATED HEREIN, AND NO OTHER WARRANTIES OR REMEDIES SHALL BE BINDING ON RAYMARINE INCLUDING WITHOUT LIMITATION ANY WARRANTIES OF MERCHANTABILITY OR FITNESS FOR A PARTICULAR PURPOSE.

(2) Raymarine shall not be liable for any incidental, consequential or special (including punitive or multiple) damages.

All Raymarine products sold or provided hereunder are merely aids to navigation. It is the responsibility of the user to exercise discretion and proper navigational skill independent of any Raymarine equipment.

Raymarine

Factory Service Centers

United States of America

Raymarine Inc
22 Cotton Road, Unit D
Nashua, NH 03063-4219, USA

Telephone: +1 603 881 5200
Fax: +1 603 864 4756
www.raymarine.com

Sales & Order Services

Telephone: +1 800 539 5539 Ext. 2333 or
+1 603 881 5200 Ext. 2333

Technical Support

Telephone: +1 800 539 5539 Ext. 2444 or
+1 603 881 5200 Ext. 2444
Email: techsupport@raymarine.com

Product Repair Center

Telephone: +1 800 539 5539 Ext. 2118

UK, Europe, Middle East, Far East

Raymarine Ltd
Anchorage Park, Portsmouth
PO3 5TD, England

Telephone: +44 (0)23 9269 3611
Fax: +44 (0)23 9269 4642
www.raymarine.com

Customer Support

Telephone: +44 (0)23 9271 4713
Fax: +44 (0)23 9266 1228

Email: techsupport@raymarine.com

Stick barcode label here

Purchased from

Purchase date

Dealer address

Installed by

Installation date

Commissioned by

Commissioning date

Owner's name

Mailing address

This portion should be completed and retained by the owner.